

Table of Contents

1	Intended Use of the iSleep 20+	3
1.1	What is the iSleep 20+?	3
1.2	Indications for Use	4
1.3	Contraindications	4
1.4	About this Manual	5
2	Safety Information	7
2.1	General User Precautions	7
2.2	Electrical Safety	8
2.3	Environmental Conditions	9
2.4	Usage of Patient Circuit	10
2.5	Usage of Filters	10
2.6	Cleaning and Maintenance	11
2.7	Adverse Patient Symptoms	11
2.8	Usage of the HA 01 Humidifier	12
2.9	Usage of Oxygen	13
3	Product Description	14
3.1	Main Components	14
3.2	The iSleep 20+'s Front Panel	16
3.3	The iSleep 20+'s Side Panels	17
3.4	Equipment Designation and Safety Label	18
4	Functions and Parameters of the iSleep 20+	19
4.1	Settings	19
5	Using the iSleep 20+	21
5.1	Checking the iSleep 20+ before Use	21
5.2	Switching the iSleep 20+ On and Off	21
5.3	Using the Menu	22
5.4	Using the integrated Humidifier	23
5.5	Using an External Battery	26
6	Preparing the iSleep 20+ for Use	28
6.1	Installing the iSleep 20+	28
6.2	Placing the iSleep 20+	29
6.3	Connecting the iSleep 20+ to the Mains Supply	29
6.4	Connecting the Patient Circuit	30
7	Setting up the iSleep 20+	31
7.1	Settings Applicable for iSleep 20+	31
7.2	Setting the Parameters	31
7.3	Viewing Device Information	32
8	Indications	33
9	Cleaning the iSleep 20+ and Replacing the Filters	36
9.1	Cleaning the iSleep 20+	36
9.2	Cleaning and Replacing the Patient Air Filter	38
10	Maintenance	39
10.1	Regular Maintenance Control	39

10.2	Service and Repair.....	40
10.3	Storage.....	40
10.4	Disposal	40
11	Technical Specifications	41
11.1	Data	41
12	Accessories.....	43
12.1	Breas Accessories List.....	43
13	Patient Settings.....	44

1 Intended Use of the iSleep 20+



WARNING!

iSleep 20+ must only be used:

- For the intended treatment in accordance with this manual and with the instructions given by the responsible clinical personnel.
- In accordance with the operating conditions specified in this manual.
- In original and unmodified shape and only with accessories specified or approved by Breas Medical AB.

Every other use may lead to risk of personal injury!



CAUTION!

Read this manual thoroughly so that you completely understand how the iSleep 20+ is operated and maintained before taking it into use, to ensure correct usage, maximum performance and serviceability.



WARNING!

Do not use the iSleep 20+ for any kind of life support treatment.



Breas Medical AB reserves the right to make changes to this product without any prior notification.

1.1 What is the iSleep 20+?

The iSleep 20+ is a CPAP system that provides a continuous positive airway pressure. This can prevent the user's upper airways from collapsing and therefore avoid breathing problems associated with airway collapse and obstruction.

The iSleep 20+ has a pressure sensor that continuously monitors output pressure to the patient and reference ambient pressure, so that the device automatically will compensate for altitude changes.

The iSleep 20+ has a memory that stores the usage, and can be downloaded by your care provider to a PC.

1.2 Indications for Use

The iSleep 20+ is intended for non-invasive use.

The iSleep 20+ shall only be used by patients with spontaneous breathing.

The CPAP function is intended to deliver continuous positive airway pressure therapy for the treatment of obstructive sleep apnea in adults (who weigh more than 30 kg).

The iSleep 20+ can be used in clinical settings (e.g., hospitals, sleep laboratories, sub-acute care institutions) and home environments. It must always be prescribed by a licensed physician.

The iSleep 20+ is intended to be operated by trained users and qualified personnel.



The iSleep 20+ is not intended for life support or life-sustaining applications or for transport of critical care patients.

1.3 Contraindications

Therapy with the iSleep 20+ should not be prescribed when the following specific diseases or conditions are present:

- Bullous lung disease
- Pathologically low blood pressure
- Severe cardiac arrhythmias
- Coronary artery disease
- Unstable angina pectoris
- Decompensated cardiac failure or hypotension, particularly if associated with intravascular volume depletion
- Recent thoracic surgery
- Pneumothorax
- Pneumomediastinum
- Massive epistaxis or previous history of massive epistaxis (risk of recurrence)

- Pneumoencephalus, recent trauma or surgery that may have produced cranio-nasopharyngeal fistula
- Cerebral spinal fluid (CSF) leaks
- Acute or unstable respiratory failure or insufficiency

Caution should be used when prescribing CPAP therapy for susceptible patients, such as patients with abnormalities of the cribriform plate, or prior history of head trauma.

The use of CPAP therapy may be temporarily contraindicated if the patient exhibits signs of a sinus or middle ear infection.

1.4 About this Manual



Always read this manual before setting up and using the iSleep 20+ or performing maintenance on the iSleep 20+, to ensure correct usage, maximum performance and serviceability.



Breas Medical AB reserves the right to make changes to the contents of this manual without any prior notification.

Audience



This manual is intended for patients and other lay users operating the iSleep 20+.





Care providers, clinical personnel, physicians and others who require a working knowledge of the iSleep 20+ will find additional information on settings and functions in the Clinician's Manual.

Icons

In this manual, icons are used to highlight specific information. The meaning of each icon is explained in the table below.

ICON	EXPLANATION
	Warning! Risk of death and serious personal injury.
	Caution! Risk of minor or moderate injury. Risk of equipment damage, loss of data, extra work, or unexpected results.

ICON	EXPLANATION
	Note Information that may be valuable but is not of critical importance, tips.
	Reference Reference to other manuals with additional information on a specific topic.

2 Safety Information

2.1 General User Precautions



- The iSleep 20+ should not be used for any kind of life support treatment.
- The iSleep 20+ shall only be used by patients with spontaneous breathing.
- If you are admitted to a hospital or are prescribed any other form of medical treatment, always inform the medical staff that you are on CPAP treatment.
- The iSleep 20+ must only be used:
 - for the intended treatment in accordance with this user manual and with the instructions given by the responsible clinical personnel;
 - in accordance with the operating conditions specified in this manual;
 - in original and unmodified shape and only with accessories specified or approved by Breas Medical AB.
- Do not use the iSleep 20+ and contact your responsible care provider for an inspection in the event of suspected damage to the device, unexplainable or sudden pressure, performance or sound changes during operation, or if the delivered air from the iSleep 20+ is abnormally hot or emits an odour.
- The iSleep 20+ therapy settings must always be based on medical advice and must be carried out by authorized clinical personnel only.
- Always perform the procedure “Checking the iSleep 20+ before Use” on page 21 before use.
- Inadequate use of device or accessories may cause loss of treatment or decreased performance.



- Clinical personnel and the patient must read the manual thoroughly and understand the usage of the iSleep 20+ before setting up and using the iSleep 20+.
- Handle the iSleep 20+ with care.
- Do not use the iSleep 20+ while in bag.

2.2 Electrical Safety



- Do not operate the iSleep 20+ if it has a damaged power cord, power supply or casing.
- The iSleep 20+ may not work properly if any part has been dropped, damaged or submerged in water.
- To avoid electrical shock, disconnect the electrical supply to the iSleep 20+ before cleaning. Do not immerse the iSleep 20+ into any fluids.
- When handling the HA 01 humidifier, disconnect the iSleep 20+ from any power source.



- If an external battery is used it must be disconnected when the iSleep 20+ is switched off. Otherwise the battery will discharge.
- The performance of the iSleep 20+ may deteriorate at:
 - AC supply voltage below -15% and above +10% of declared nominal value.
 - DC supply voltage below -15% and above +25% of declared nominal value.

2.3 Environmental Conditions



- Do not use the iSleep 20+ in any toxic environment.
- Do not use the iSleep 20+ in environments where there are explosive gases or other flammable anesthetic agents present.



- The performance of the iSleep 20+ may deteriorate at:
 - ambient temperatures below 5°C (41°F) and above 40°C (104°F).
 - ambient relative humidity below 10% RH (relative humidity) and above 95% RH.
 - atmosphere pressure below 700 mbar and above 1060 mbar.
- Do not use the iSleep 20+ while positioned in a warm place, such as direct sunlight.
- The device complies with the EMC requirements of standards. Measures should include but not be limited to:
 - normal precautions with regard to relative humidity and conductive characteristics of clothing in order to minimize the build-up of electrostatic charges.
 - avoiding use of radio emitting devices closer than 1 m to the iSleep 20+. Radio emitting devices are for example cellular or cordless telephones, microwave ovens and high-frequency surgery apparatus.
- The iSleep 20+, any accessories and all replaced parts must be disposed of in accordance with the local environmental regulations regarding the disposal of used equipment and waste.
- The performance of the iSleep 20+ and treatment of the patient may deteriorate if the operation conditions in “Technical Specifications” on page 41 are not fulfilled. Do not use the iSleep 20+ immediately after storage or transport outside the recommended operating conditions.

2.4 Usage of Patient Circuit



- Only use the iSleep 20+ with a mask, patient tube and ventilation valve (if applicable) recommended by Breas Medical AB and your health care professional.
- Do not breathe in the connected patient circuit unless the iSleep 20+ is turned on and operating properly.
- Do not use patient hoses or tubes made of electrically conductive or static material.
- Patient connected parts and filter must be replaced regularly to ensure correct function of the iSleep 20+. All replaced parts must be disposed of according to local environmental regulations regarding the disposal of used equipment and parts.
- If the patient is using a full face mask (covering mouth and nose), the mask must be equipped with a safety entrainment valve.
- Make sure that the ventilation holes in the mask or the adjoining ventilation valve are never blocked or obstructed. These devices are used for ventilating the mask in order to prevent re-breathing of exhaled air. Re-breathing of exhaled gases for longer than a few minutes can, in some circumstances, lead to suffocation.
- At low CPAP pressures, the air flow through the ventilation holes in the mask or the adjoining ventilation valve may be inadequate to clear all exhaled gases from the mask. Some re-breathing may occur.

2.5 Usage of Filters



- Always use the iSleep 20+ with a patient air inlet filter installed. Only use filters that are specified in this manual.
- Replace or clean the filters regularly to ensure correct function of the iSleep 20+, especially when changing patient. Failure to replace or clean a dirty filter may cause the iSleep 20+ to operate at higher temperatures than intended.
- When operating the iSleep 20+, make sure that the air inlet and the filter is not obstructed or occluded.

2.6 Cleaning and Maintenance



- The iSleep 20+ shall be cleaned and maintained in accordance with this user manual.
- Do not attempt to autoclave or sterilise the iSleep 20+.
- The iSleep 20+ shall be subjected to maintenance, service and control and any applicable upgrades, in accordance with Breas service instructions.
- The iSleep 20+ should only be repaired or modified in accordance with Breas service manuals, technical bulletins, and any special service instructions, by service technicians authorized by Breas Medical AB.
- Do not under any circumstances attempt to service or repair the iSleep 20+ yourself. If you do so, the manufacturer will no longer be responsible for the performance and safety of the iSleep 20+.

2.7 Adverse Patient Symptoms



If the patient experiences any of the following symptoms while using the iSleep 20+, a physician or responsible clinician shall be contacted immediately:

- Bloating feeling from excessive swallowing of air while awake
- Air continually leaking from the mouth while sleeping
- Dryness of air passages or nose
- Ear pain, runny nose or sinus discomfort
- Day time sleepiness
- Disorientation or memory lapse
- Mood change or irritability
- Skin sensitivity
- Morning headache

2.8 Usage of the HA 01 Humidifier



- The HA 01 humidifier and the iSleep 20+ are intended for non-invasive use.
- When using an external humidifier, it should be located below the iSleep 20+ and the patient to prevent personal injury from accidental spillage.
- When using the HA 01 humidifier, the iSleep 20+ should be located below the patient to prevent personal injury from accidental spillage.
- If a room humidifier is used, place it at least 2 meters away from the iSleep 20+.
- Periodically check for moisture in the patient circuit. When present, remove the moisture. Before attempting to dry the circuit, disconnect it from the iSleep 20+ to ensure no water back-flow into the iSleep 20+. The frequency at which these checks must be performed will depend on the patient's own condition and the device used. This should be assessed on an individual basis in accordance with the patient's needs.
- If the condensation in the patient circuit is excessive, the use of a heated humidifier may require the installation of a water trap in the circuit. The water trap prevents any condensed water in the patient circuit from running into the patient airways and causing personal injury.



- The HA 01 humidifier shall be disconnected from the iSleep 20+ during transportation.
- The iSleep 20+ shall not be placed in the bag with the HA 01 humidifier attached.

2.9 Usage of Oxygen



- The presence of oxygen can speed up combustion of inflammable materials.
- If oxygen has been prescribed, connect the oxygen supply tube to the appropriate oxygen port of the nasal mask or breathing system connector.
- At a fixed flow rate of supplemental oxygen flow, the inhaled oxygen concentration will vary, depending on the pressure delivered, patient's breathing pattern, mask selection, and leak rate.
- When oxygen is used with the iSleep 20+, the oxygen flow must be turned off when the iSleep 20+ is not operating. If the iSleep 20+ is not in operation, and the oxygen flow is left on, oxygen delivered into the patient tubing may accumulate within the iSleep 20+ enclosure. Oxygen accumulated in the iSleep 20+ enclosure will create a risk of fire.
- Ventilate the room adequately.
- Do not smoke in a room where oxygen is being used.
- Naked light bulbs and other sources of ignition must be kept a minimum of 2 metres away from the oxygen cylinder or any part of the patient circuit.
- Do not use aerosols or solvents close to the oxygen supply, even when the oxygen supply is shut off.

3 Product Description

3.1 Main Components

The iSleep 20+ system contains the following components:

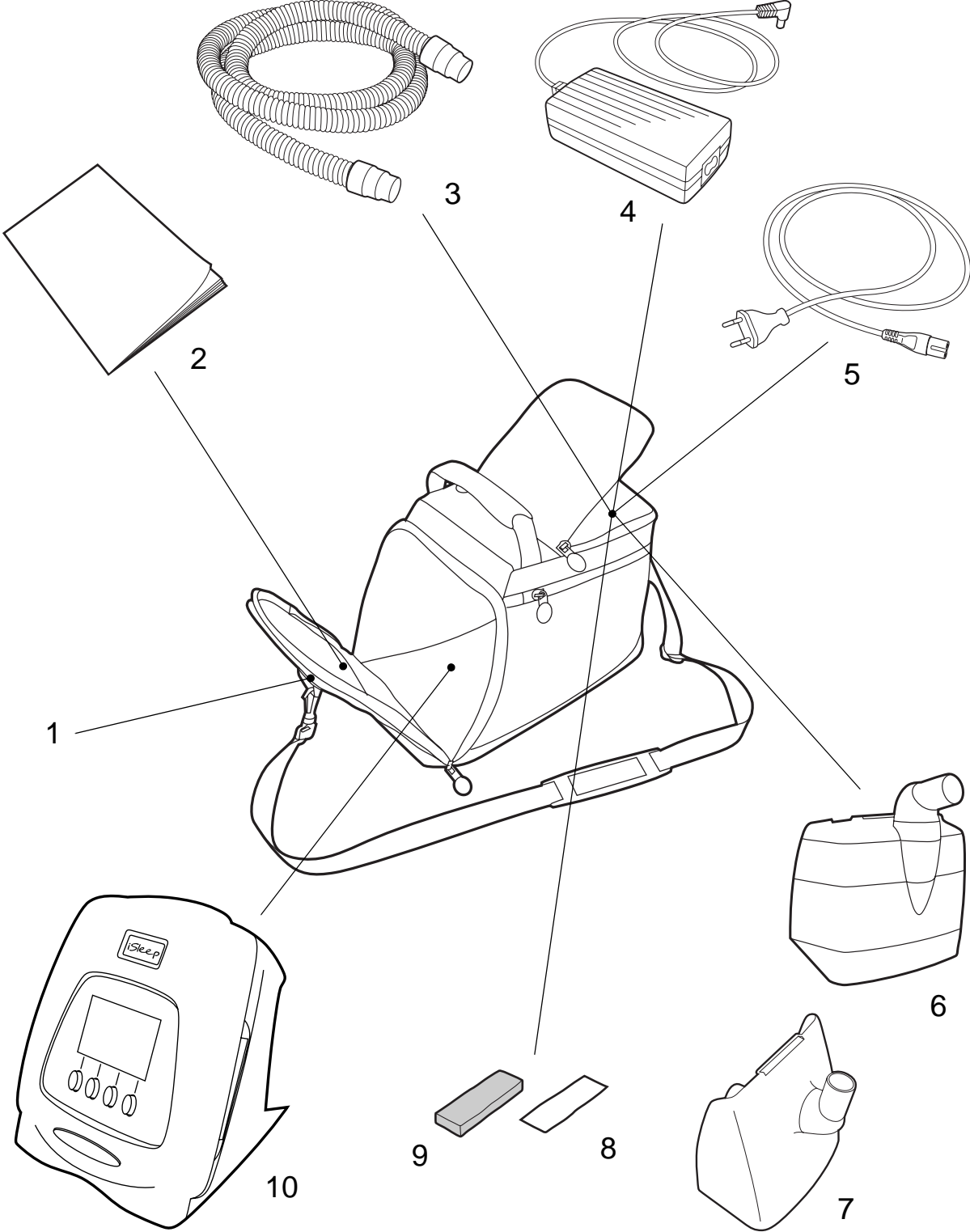

No.	COMPONENT	FUNCTION	PART NO.
1	Carrying bag	Storage for transportation	003793
2*	Users manual	Product and usage information	004270
3*	Patient tube	Tube for mask and iSleep 20+	000245
4*	iSleep power supply		003773
5*	Mains power cord		003723
6	HA 01 Humidifier	Patient air humidification	003530
7*	Rear lid	Usage without HA 01 Humidifier	003591
8*	Filter (white, disposable, optional)	Inlet air filtration	003762
9*	Filter (grey, washable)	Inlet air filtration	003693
10*	iSleep 20+ main unit		

* Included in the iSleep 20+ basic package.

3.2 The iSleep 20+'s Front Panel

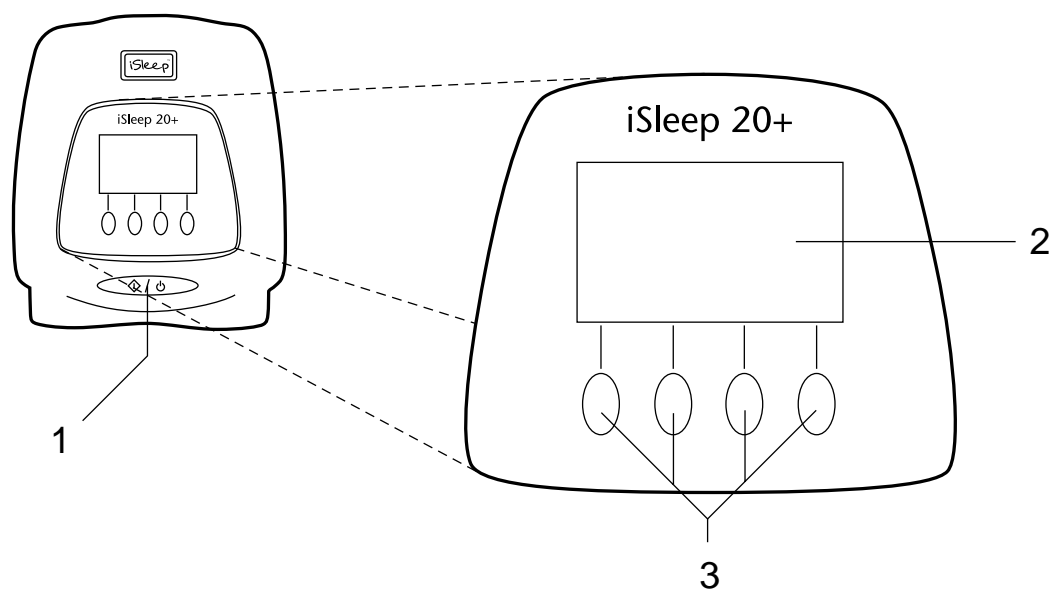

No.	USER BUTTONS AND DISPLAYS	FUNCTION
1	Start/Stop	Main unit: On/Off
2	Display window	Mode and settings display
3	Navigation	Navigation in menu system

3.3 The iSleep 20+'s Side Panels

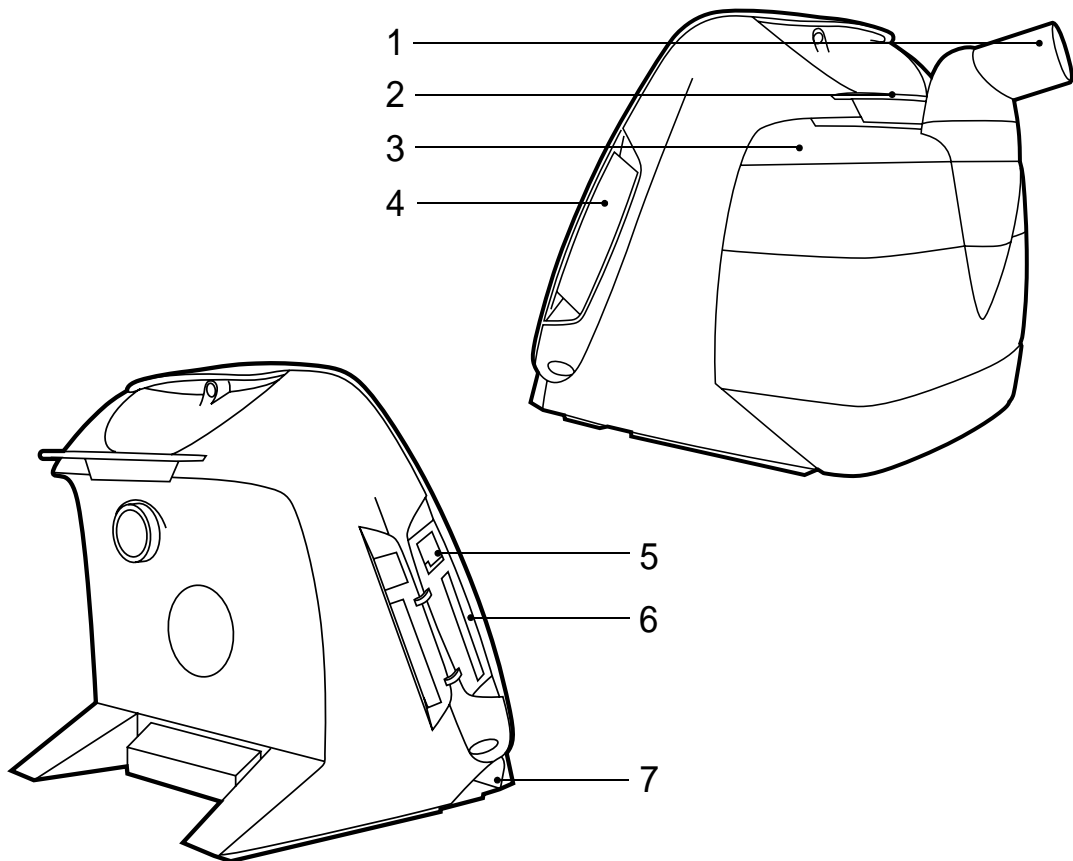

No.	ITEM	FUNCTION
1	Air outlet	Air path out to the patient
2	Locking mechanism	Release and lock HA 01 humidifier or rear lid
3	HA 01 Humidifier (optional)	Patient air humidification
4	Air inlet	Air path in, replaceable filters
5	Data connection	Data cable connection
6	Memory card slot	Read and write memory card
7	DC inlet	External DC power connection

3.4 Equipment Designation and Safety Label

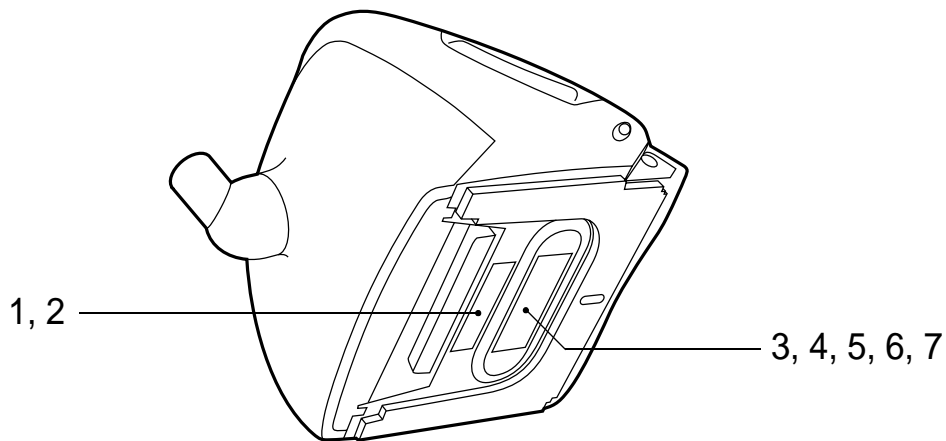

No.	SYMBOL	EXPLANATION
1		Model designation
2		Serial number (the last seven alphanumeric characters)
3		Class II electrical equipment; dual isolation
4		Body floating (IEC 60601-1 Type BF, Isolated Applied Part)
5		Read the User Manual thoroughly before connecting the iSleep 20+ to the patient.
6		CE marking applies in accordance with the directive MDD 93/42/EEC.
7		Read “Disposal” on page 40 for information about recycling and disposal.

4 Functions and Parameters of the iSleep 20+

4.1 Settings

All the parameters that are used for controlling the breathing by the iSleep 20+ are listed below.

The Ramp function

The ramp function provides a pressure increase from the ramp start pressure to the set CPAP pressure during a set time.

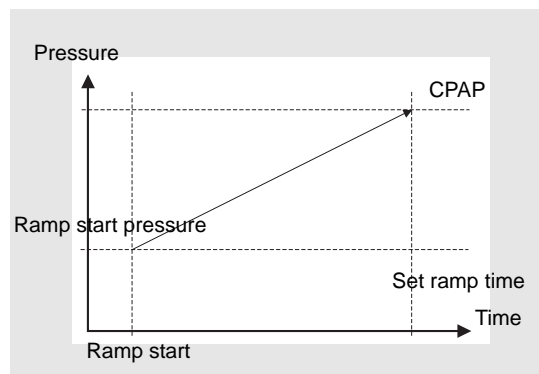

The ramp function will not be available if your care provider has chosen to deactivate it.

Mask-Off Detection

The iSleep 20+ automatically detects if the mask is taken off during operation and reduces the air flow.



If the patient removes the mask, the iSleep 20+ will minimise the pressure to approximately 1 cmH₂O (the pressure level depends on the mask type). When the patient has put on the mask again and taken a few breaths, the iSleep 20+ will go back to the pressure delivered before the patient removed the mask.

The iSleep 20+ will exclude any mask-off time and ramp time when registering the patient operating time.



If the mask is not fitted properly to the patient, the iSleep 20+ may incorrectly detect that the mask is taken off and may change the delivered pressure to the reduced mask-off level. In this case, check the mask fitting and adjust it if necessary.

Snooze

The snooze function allows the patient to pause the treatment. This is done by shortly pressing the Start/Stop button. When the snooze is started, the display will lighten up and the iSleep 20+ delivers a low flow.



In order to start the treatment again, start to breath in the mask or press the Start/Stop button shortly. The iSleep 20+ will then increase the pressure to the set level during up to 10 seconds.

The iSleep 20+ will turn off automatically after 10 minutes of inactivity once the snooze function has been activated.

Once the snooze is activated, and the mask has not been taken off within 10 seconds, the pressure will rise to the pressure set before the snooze function was activated.

Humidifier (optional)

The humidifier function is adjustable to provide additional humidity to the patient air.

Automatic Restart After Power Fail

The iSleep 20+ will restart after a power failure with a duration shorter than 5 seconds.

Wake Up (optional)

The wake up function will initiate an alarm at a set time when activated. Press the Start/Stop button to turn off the alarm.

5 Using the iSleep 20+

5.1 Checking the iSleep 20+ before Use

Always make the following checks before using the iSleep 20+:

- 1 Connect a cleaned or a new patient circuit to the iSleep 20+.
- 2 Connect the iSleep 20+ to the mains supply.
- 3 Check patient settings.
- 4 Switch on the iSleep 20+ by pressing the Start/Stop button on the front panel. Ensure that the iSleep 20+ is running.
- 5 Put on the mask and adjust its fit.
- 6 Ensure that the settings are adjusted as prescribed.

The iSleep 20+ is ready for use.

5.2 Switching the iSleep 20+ On and Off

- 1 Make sure the power supply is connected.

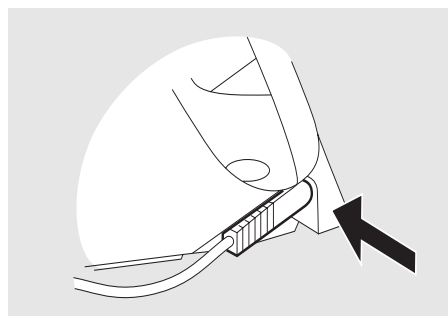

- 2 Turn on the iSleep 20+ by pressing the Start/Stop button on the front panel for 2 seconds.

This operation switches the iSleep 20+ between standby and operating mode.

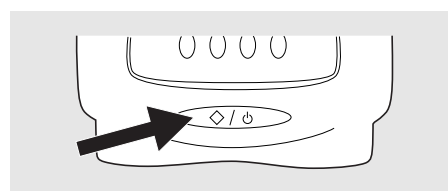

The iSleep 20+ is connected to a power supply when the LCD display is lit up.

5.3 Using the Menu



Read chapter “The iSleep 20+'s Front Panel” on page 16 for exact position of the buttons.

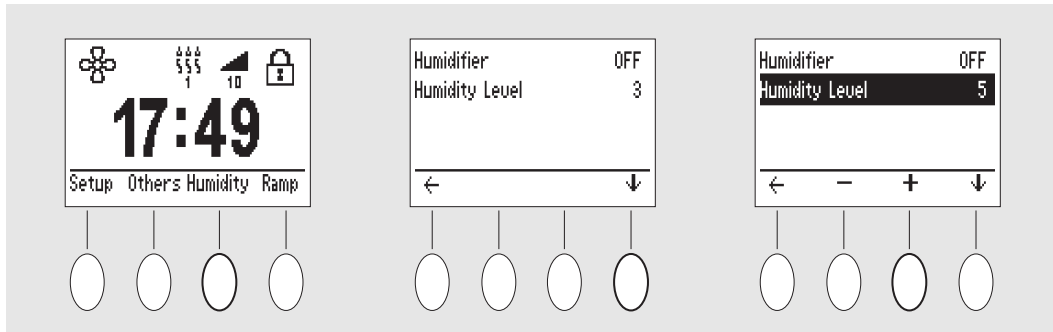

Use the 4 buttons under the display to navigate in the menu. Depending on the location in the menu, the buttons have different function. The following icons are used:





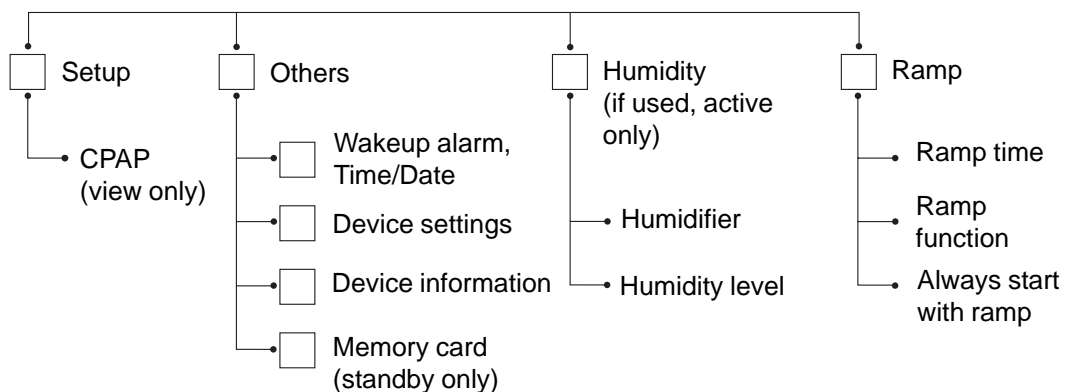

ICON	EXPLANATION
+	Increase the selected value or turn a function On.
-	Decrease the selected value or turn a function Off.
←	Move up one step in the menu system.
↓	Enter the menu or select the value below.

Overview

The iSleep 20+ menu has the following layout:



Icons in the Display Window

ICON	EXPLANATION
	The iSleep 20+ is operating
	Wake up alarm
	Humidity
	Ramp
	Panel lock
	Panel lock

5.4 Using the integrated Humidifier



Read the chapter “Usage of the HA 01 Humidifier” on page 12 carefully to make sure all conditions are fulfilled and considered.

The humidifier is intended to humidify the patient air. The humidifier must be installed in order to access this setting, since it is applicable for humidifier navigation in both clinical and home mode.

A full humidifier will be able to humidify the air for about 11 hours with the following settings and conditions:

SETTING	VALUE
Humidifier setting	5
CPAP pressure	10 cmH ₂ O
Ambient temperature	20°C (68°F)
Leakage	20 l/min
Altitude	Sea level

At the main menu, choose “Humidity” to navigate to the humidifier section. The humidity setting range from Off, 1 to 9, where 9 generates the maximum humidity.

Always set the humidity control to the setting recommended by your doctor.

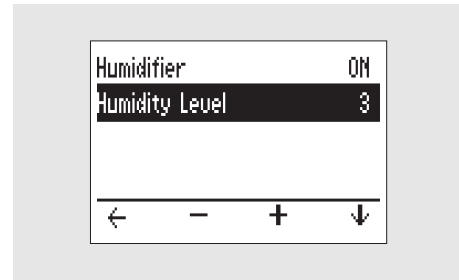

Adding Water to the Humidifier



- Never add or pour out water from the humidifier when attached to the iSleep 20+ main unit.
- Prevent water from entering the iSleep 20+.
- Always turn off the iSleep 20+ and disconnect the mains supply before removing the humidifier.
- Do not use the humidifier if the internal pipe in the water container is missing.
- Do not overfill the humidifier.
- If water on outside of the humidifier after filling, dry the humidifier using a lint-free cloth before reconnecting it to the iSleep 20+.

Follow the instruction in the illustration below. Use the same procedure when emptying water from the humidifier.

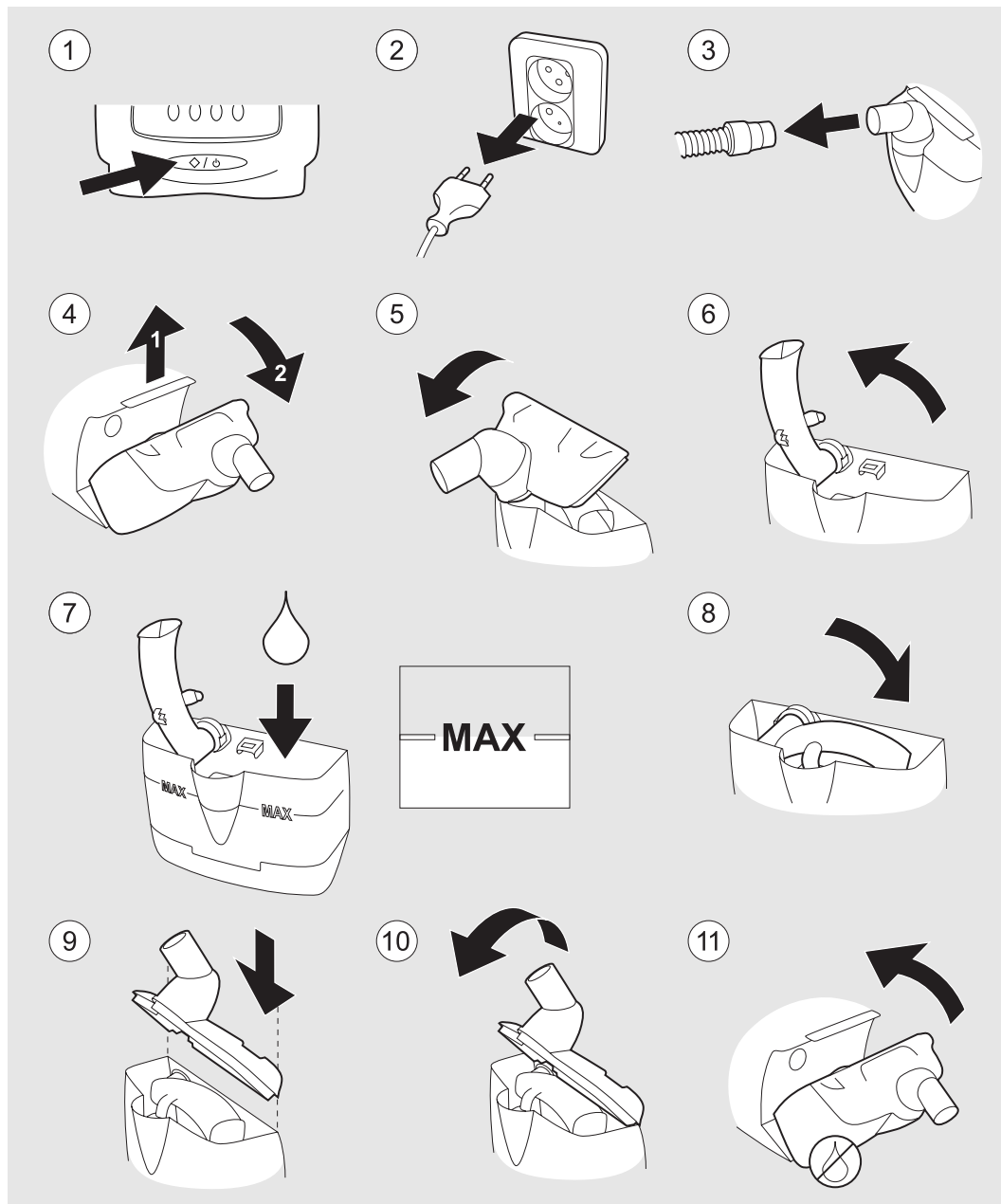

Add distilled water or boiled, chilled tap water to the humidifier until it reaches the marking “Max” on the humidifier. A full humidifier contains approximately 400 ml. Do not overfill the humidifier.

Cleaning the Humidifier

- Clean with hot water and a mild detergent or in a dishwasher without dishwasher detergent at max 70°C. Rinse carefully and allow to dry.

5.5 Using an External Battery

The iSleep 20+ can be powered from:

- The Breas external EB 2 Battery Pack.
- A 12 V external power source. The iSleep DC converter 12-24 V needs to be used.

1 Connect the external DC cable to the iSleep 20+. Make sure it is fitted correctly.

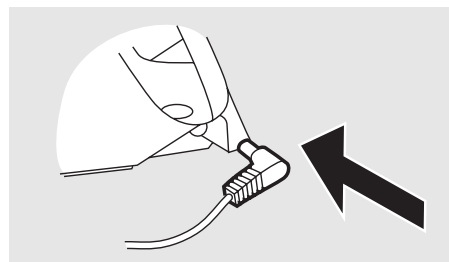

2 Connect the other end of the cable to the battery source.



- Always make a function check to test the battery condition before operating the iSleep 20+ from an external battery source.
- The battery must be disconnected when the iSleep 20+ is switched off, otherwise the battery will be discharged.

Battery Operation Time

The operation time is dependent on the battery condition, its capacity, the ambient air temperature and the iSleep 20+ pressure setting.

The operation time is based on the following settings:

SETTING	VALUE
Humidifier setting	5 or Off
CPAP pressure	10 cmH ₂ O
Ambient temperature	20°C (68°F)
Altitude	Sea level
Battery status	New battery fully charged

BATTERY TYPE	HUMIDIFIER	OPERATION TIME
EB 2 (24 V, 7.2 Ah)	Off	13 h

BATTERY TYPE	HUMIDIFIER	OPERATION TIME
EB 2 (24 V, 7.2 Ah)	5	Not recommended
Car battery (12 V, 60 Ah)*	Off	90 h
Car battery (12 V, 60 Ah)*	5	25 h

* When using a 12 V external power, the iSleep DC converter 12-24 V needs to be used.

6 Preparing the iSleep 20+ for Use



Read the chapter “Safety Information” on page 7 before setting up and using the iSleep 20+.

6.1 Installing the iSleep 20+

When using the iSleep 20+ for the first time, follow the instructions below:

1 Check that all main components and ordered accessories have been delivered (refer to the packing note or the invoice, if available).

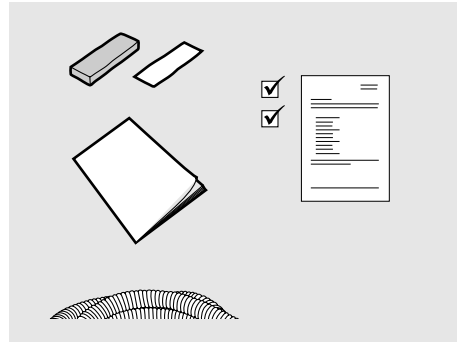

2 Ensure that the equipment is in good condition.

3 Check that the mandatory grey patient air filter is installed.

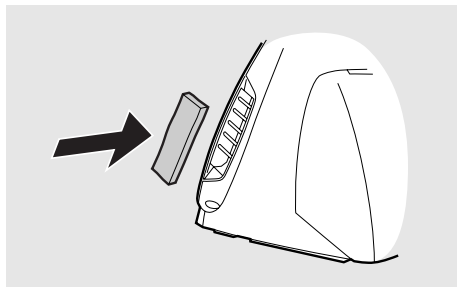

6.2 Placing the iSleep 20+



Read the chapter “Environmental Conditions” on page 9 carefully to make sure all conditions are fulfilled and considered.

1 Place the iSleep 20+ on a solid, flat surface. The iSleep 20+ should be placed lower than the patient in order to prevent the device from falling on the user.

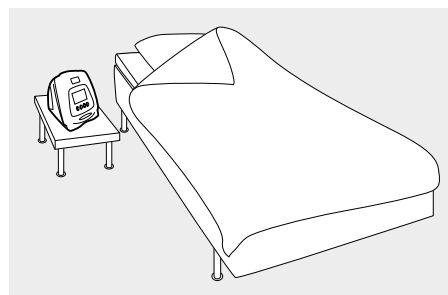

2 Make sure that nothing can block the patient air inlet at the side of the iSleep 20+.

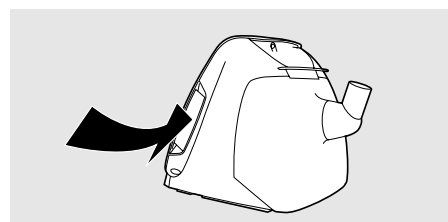

6.3 Connecting the iSleep 20+ to the Mains Supply



Read the chapter “Electrical Safety” on page 8 carefully to make sure all conditions are fulfilled and considered.

To Connect the iSleep 20+ to the Mains Supply:

1 Plug the power supply into the power inlet of the iSleep 20+.

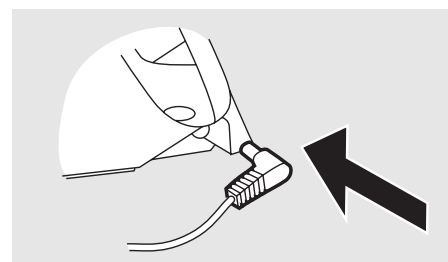

2 Connect the power cord into the power supply.

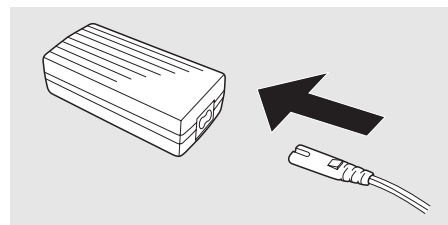

3 Connect the power cord to the mains supply.

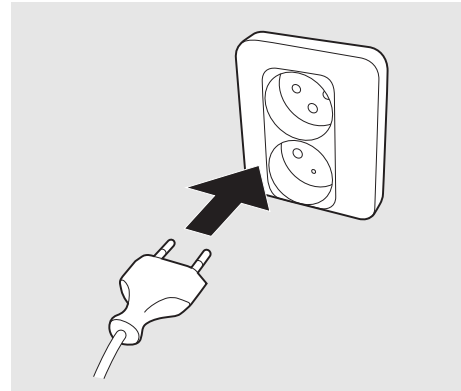

6.4 Connecting the Patient Circuit



Read the chapter “Usage of Patient Circuit” on page 10 carefully to make sure all conditions are fulfilled and considered.

1 Connect the patient tube to the air outlet.

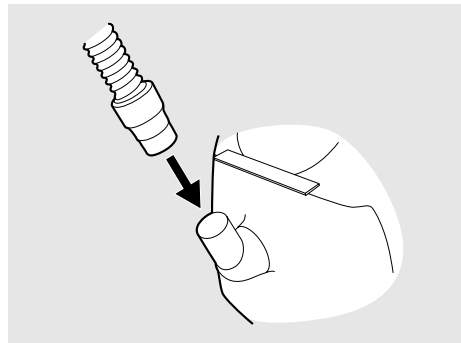

2 Connect the other end of the patient tube to the mask and the ventilation valve, if applicable.

Mask Leakage

The leakage from the mask should be at least 12 l/min at 4 cmH₂O, to prevent re-breathing of exhaled air. The recommended mask leakage is 20-40 l/min at 10 cmH₂O pressure.

This leakage may be achieved by:

- small holes in the mask
- an adjoining ventilation valve



In order to receive a suitable leakage the Breas iMask™ Nasal CPAP Mask is recommended.

7 Setting up the iSleep 20+



The configuration of the iSleep 20+ therapy settings must always be prescribed by a licensed physician and carried out by an authorized health care professional.



For more information about the Breas iSleep 20+'s settings, please contact your care provider.

7.1 Settings Applicable for iSleep 20+

SETTING	RANGE	RESOLUTION
Ramp time	5 to 60 min	5 min
Humidifier	Off, 1 to 9	1



The operation modes and setting parameters are described in detail in the chapter “Functions and Parameters of the iSleep 20+” on page 19.

7.2 Setting the Parameters



For more information about how to use the menu, please read the chapter “Using the Menu” on page 22.

Study the overview picture in “Using the Menu” on page 22 if a page or section can not be found.

The Ramp function

Setting range: 5 to 60 min.

Resolution: 5 min.

Navigate to the “Ramp” section. The ramp function can only be activated during operation.

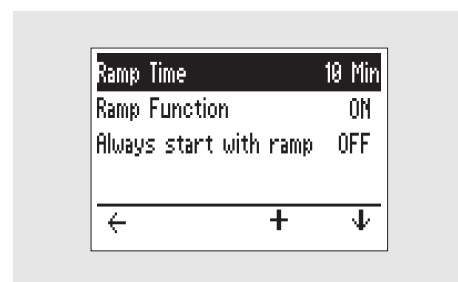

Humidifier (optional)

Setting range: 1 to 9, Off (where 9 is the maximum humidity).

Navigate to the “Humidity” section. If the HA 01 humidifier is not attached to the iSleep 20+, the “Humidity” section will not be available in the menu.

The HA 01 humidifier can only be activated during operation.

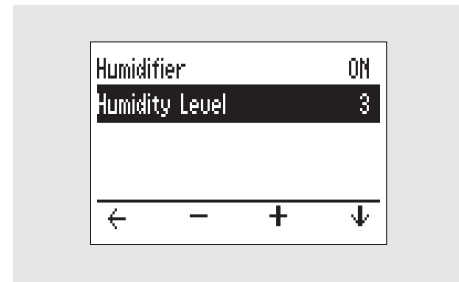

7.3 Viewing Device Information



Check the chapter “Using the Menu” on page 22 for information about how to navigate to the device info screen.

At the main menu, choose “Others” and navigate to the “Device Information” page.

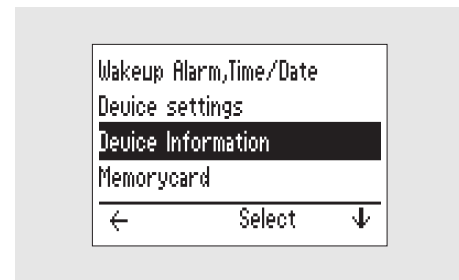

The “Device Information” page contains the following information:

1 Total Operating Time:
Total number of hours the iSleep 20+ has been operating.

2 Patient Operating Time:
Total number of hours a patient has been using the iSleep 20+ for CPAP treatment (ramp and mask off not included).

3 Software Version.

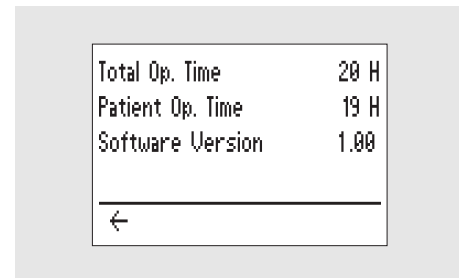

8 Indications

This chapter describes the iSleep 20+'s indication functions, messages shown in the display window.

Power Fail Indication

ITEM	DESCRIPTION
Definition	A power fail indication will be given when the iSleep 20+ is disconnected from the mains power source more than 5 seconds.
Action	The iSleep 20+ will terminate treatment.
Indication	The indication is asserted with an audible tone.
Reset	In order to reset the indication press the Start/Stop button.

Internal Function Error

ITEM	DESCRIPTION
Definition	An internal function error will be given when the iSleep 20+ has an internal function failure. The following error codes exist:

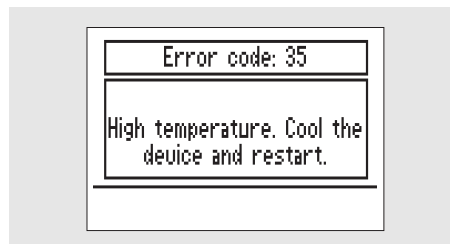

35: High temperature. Let the iSleep 20+ cool down and restart. The ambient temperature might be too high.

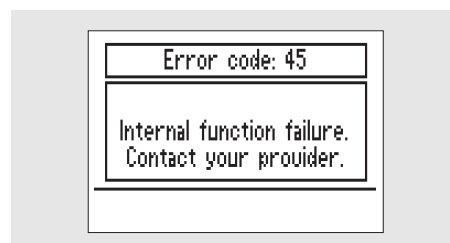

ITEM**DESCRIPTION**

45: Internal function failure. Contact your care provider.

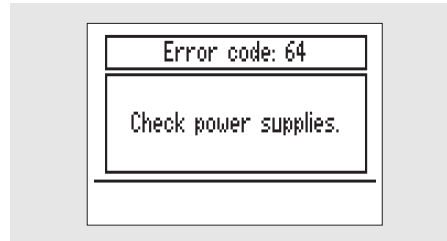

64: Low power. Check the power cables and the mains connection.

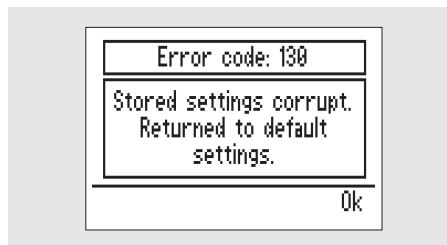

130: Settings corrupt. Check that the settings of the iSleep 20+ are according to prescription.

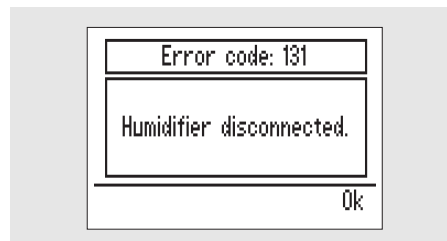

131: The HA 01 humidifier has been disconnected when the iSleep 20+ was running. Always turn of the iSleep 20+ before disconnecting the HA 01 humidifier.

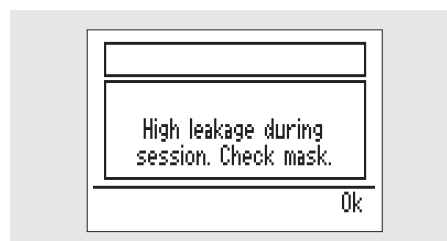

ITEM	DESCRIPTION
	<p>The leakage has been too high during the night for an accumulated time longer than 30 minutes. Check the mask fitting.</p>
	<div data-bbox="647 450 1099 689" data-label="Image"> <p>The image shows a rectangular display window with a white background and a black border. At the top, it reads 'Error code: 133'. Below that, it says 'Low humidifier temperature. Check humidifier.' At the bottom right corner, there is an 'Ok' button.</p> </div> <p>133: Low humidifier temperature. Check that the humidifier is connected correctly (this error is shown after the treatment session). If the error remains, contact your care provider.</p>
	<div data-bbox="647 943 1099 1182" data-label="Image"> <p>The image shows a rectangular display window with a white background and a black border. At the top, it reads 'Error code: 134'. Below that, it says 'High humidifier temperature. Check humidifier.' At the bottom right corner, there is an 'Ok' button.</p> </div> <p>134: High humidifier temperature. Turn off the iSleep 20+. Disconnect the humidifier and reconnect it. If the error remains, contact your care provider.</p>
<p>Action</p>	<p>The iSleep 20+ will continue or stop the treatment depending on the type and priority of the event.</p>
<p>Indication</p>	<p>The indication is asserted audible with a tone and visible by a display message.</p>
<p>Reset</p>	<p>If possible, correct the error cause and disconnect and connect the mains power source. If the error remains, contact your care provider.</p>

9 Cleaning the iSleep 20+ and Replacing the Filters

The patient-connected parts and the filter must be cleaned and replaced regularly to ensure correct function of the iSleep 20+. All replaced parts must be disposed of in accordance with local environmental regulations regarding the disposal of used equipment and waste.

9.1 Cleaning the iSleep 20+



To avoid electrical shock, disconnect the mains supply to the iSleep 20+ before cleaning. Do not immerse the iSleep 20+ into any fluids.



- Always be careful when cleaning to ensure that you do not damage any equipment.
- Fluid must not be allowed to enter into the iSleep 20+.

Main Unit

1 Switch off the iSleep 20+ and disconnect the mains supply.

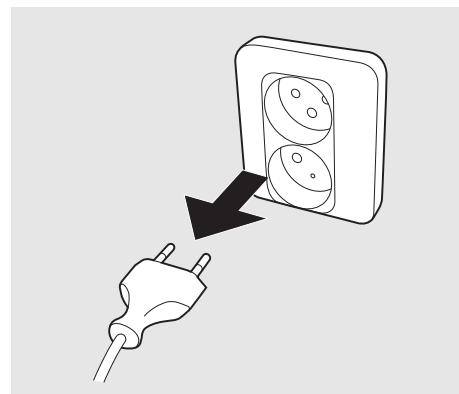

2 Remove the patient circuit.

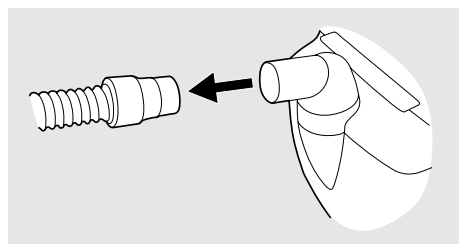

3 Detach the rear lid or the humidifier.

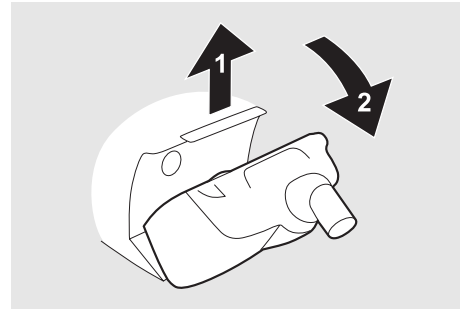

4 Disconnect the cable.

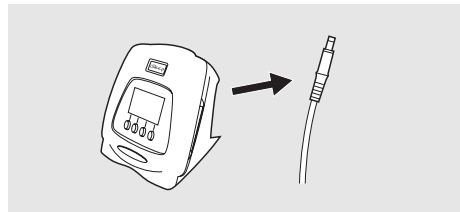

5 Clean the outside of the iSleep 20+ using a lint-free cloth and a mild detergent solution.

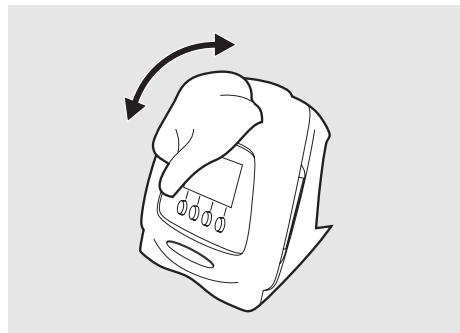

6 Reconnect the cable and the patient circuit. Make sure all parts are dry before the iSleep 20+ is put into operation.

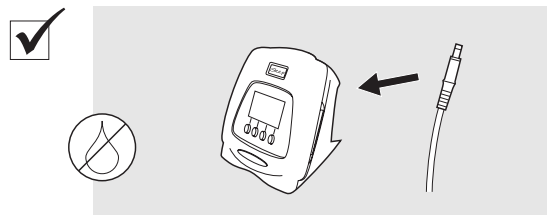

HA 01 Humidifier

The HA 01 humidifier must be cleaned regularly.



Information on cleaning the HA 01 humidifier can be found in the Breas HA 01 humidifier User Manual.

The HA 01 humidifier shall be replaced in intervals according to the care provider's instructions. Also check the HA 01 humidifier for damage regularly. In case of damage, replace the HA 01 humidifier.

Patient Circuit



The patient circuit should be cleaned in accordance with the care provider's instructions.

Always clean the parts or use a new set when used by a new patient.

All parts that come into contact with the respiration gas must be cleaned as follows:

- 1 Place the dismantled parts in hot water containing washing-up liquid.
- 2 Remove fouling with a brush.
- 3 Rinse parts thoroughly under running hot water.
- 4 Shake water out of all parts.
- 5 Dry the parts completely.
- 6 Store in dust-free location.

The patient circuit shall be replaced in intervals according to the care provider's instructions. Check the patient circuit for damage regularly. In case of damage, replace the circuit.

9.2 Cleaning and Replacing the Patient Air Filter

The patient air filter is located on the side of the iSleep 20+. There are two types of filters:

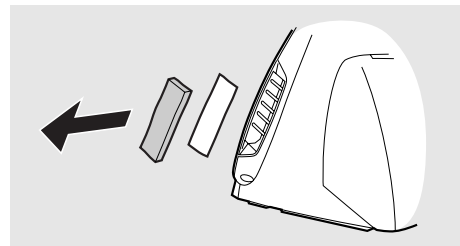

Washable Filter (grey colour, mandatory)

Replace the washable filter at least once a year. Wash the filter at least once a week.

- 1 Wash the filter using warm water and a mild detergent.
- 2 Rinse thoroughly.
- 3 Dry the filter by squeezing it out in a towel. Do not wring the filter.

Disposable Filter (white colour, optional)

Replace the filter at least every 4th week, or more often when used in high pollution or pollen-rich environments.



Do not wash or reuse the disposable filter.

10 Maintenance



WARNING!

- iSleep 20+ should be subjected to maintenance, service and control and any applicable upgrades, in accordance with Breas service instructions.
- iSleep 20+ should only be repaired or modified in accordance with Breas service manuals, technical bulletins, and any special service instructions, by service technicians that have been authorized after Breas iSleep 20+ service training.
- Do not under any circumstances attempt to service or repair the iSleep 20+ yourself. If you do so, the manufacturer will no longer be responsible for the performance and safety of the iSleep 20+.

DEVIATION FROM THESE SERVICE INSTRUCTIONS MAY LEAD TO RISK OF PERSONAL INJURY!

10.1 Regular Maintenance Control

The iSleep 20+ should not require any regular maintenance inspections if it is used and maintained in accordance with the instructions in this manual.



Do not use the device and contact your responsible care provider for an inspection of the device in the event of:

- Unexpected patient symptoms during treatment.
- Unexplainable or sudden pressure, performance or sound changes during operation.
- Suspected damage to the device or power supply.

10.2 Service and Repair

The service and repair of the iSleep 20+ must only be carried out by authorized service personnel in accordance with Breas service instructions. Service inspections must always be carried out after any repair of the device.



Authorized service workshops can order the iSleep 20+ Service Manual that contains all technical documentation required for the maintenance and service of the iSleep 20+.

10.3 Storage

Empty, clean and dry the humidifier (if applicable) before storage of the iSleep 20+.

10.4 Disposal

The iSleep 20+, any accessories and all replaced parts must be disposed of and recycled in accordance with the local environmental regulations regarding the disposal of used equipment and waste.

11 Technical Specifications

11.1 Data



The iSleep 20+ and its packaging do not contain any natural rubber latex.

SETTING/VALUE	RANGE/SPECIFICATION	RESOLUTION
CPAP	4 to 20 cmH ₂ O	0.5 cmH ₂ O
Ramp time	5 to 60 min	5 min
Ramp start pressure	4 cmH ₂ O to CPAP	0.5 cmH ₂ O
Humidifier	1 to 9, 10 to 30 mgH ₂ O/l, <100% RH. Heat-up time from 23°C: 1 hour. Max gas temperature at patient port: 41°C.	1
Maximum flow	>125 l/min	
Maximum limited pressure during single fault condition	30 cmH ₂ O	
Max flow in CPAP mode	6.7 cmH ₂ O: 108 l/min 13.3 cmH ₂ O: 132 l/min 20 cmH ₂ O: 132 l/min	
Breathing resistance under single-fault	0.9 cmH ₂ O at 30 l/min 3.2 cmH ₂ O at 60 l/min	
Digital output	0 to 5 V	
Sound level at 10 cmH ₂ O	Less than 30 dB(A). Measured at 1 m.	

INDICATIONS	SPECIFICATION	TOLERANCE
Pressure	0 to 20 cmH ₂ O	
Power fail indication	Message shown in the display.	

INDICATIONS	SPECIFICATION	TOLERANCE
Internal function indication	Message shown in the display.	

POWER SUPPLIES	SPECIFICATION
Mains supply	100 to 240 V AC, tolerance: -15%/+10%, 50 to 60 Hz, max 140 VA. DC output: 24 V.
External DC supply	24 V DC, tolerance: -15%/+25% (20.4 to 30 V). Max 2.5 A, 60 W with Breas external battery.
Standby power	3 W

ENVIRONMENTAL CONDITIONS	SPECIFICATION
Operating temperature range	5 to 40°C (41 to 104°F)
Storage and transport temperature	-20 to +60°C (-4 to +140°F)
Ambient pressure range	700 to 1060 mbar
Humidity	10% to 95%, non-condensing

OPERATING CONDITIONS	SPECIFICATIONS
Recommended leakage	20 to 40 l/min at 10 cmH ₂ O
Minimum leakage	12 l/min at 4 cmH ₂ O

DIMENSIONS	SPECIFICATIONS
W × H × D	173 × 172 × 209 mm (with rear lid) 173 × 172 × 201 mm (with HA 01 humidifier)
Weight	1.9 kg (with rear lid), 2.0 kg (with HA 01 humidifier)
Air outlet	22 mm male conical standard connector

12 Accessories

12.1 Breas Accessories List



Only use accessories recommended by Breas Medical AB. Breas Medical AB cannot guarantee the performance and safety for the use of other accessories with the iSleep 20+.

The following Breas accessories are currently available for the iSleep 20+:

DESCRIPTION	PART No.
Carrying bag	003793
Users manual	004270
Patient tube	000245
Humidifier	003530
Rear lid	003591
Filter (grey, washable)	004154 (5 pcs)
Filter (white, disposable, optional)	004153 (5 pcs)
iMask 100	003971
iMask 200	003972
Breas one-size headgear	003434
iSleep power supply	003773
Mains power cord	003723
EB 2 external battery pack 24 V DC, including cable, charger and bag	004150
External DC cable (EB 2)	004136
TrafoBox EB 2 external battery	001153
Charger EB 2 external battery	001159
Carrying bag EB 2 external battery	000269
EB 2 power cord	000539
iSleep DC converter 12-24 V	004139

13 Patient Settings

Patient Settings - Breas iSleep 20+

Patient
Date
Clinic
Set by
iSleep 20+ serial number

CPAP Humidifier
Ramp Time Ramp Start Pressure

Notes
.....
.....
.....
.....
.....
.....
.....
.....
.....
.....