



**VPAP™ III & III ST
User Manual**

English

248127/1
VPAP III & III ST User Manual
ENG

VPAP™ III & III ST

Illustrations

Component of 248127/1

A SYSTEM COMPONENTS

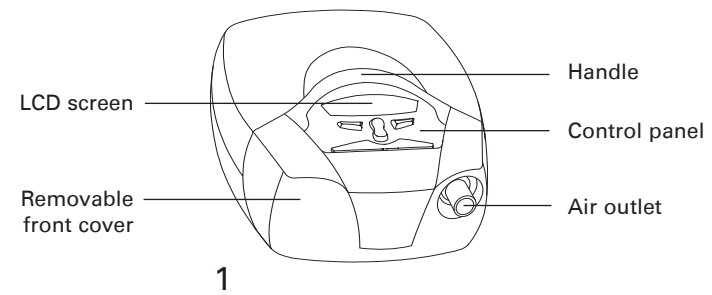

1

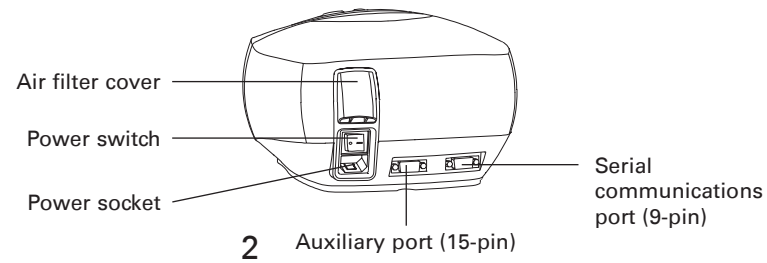

2



3

4

5

2 m

© 2005 ResMed Ltd.

B HUMIDIFIERS

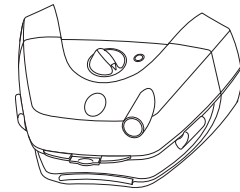

1 HumidAire 2i™

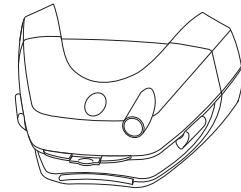

2 HumidAire 2iC™

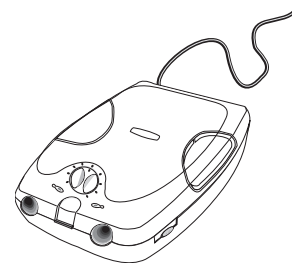

3 HumidAire™

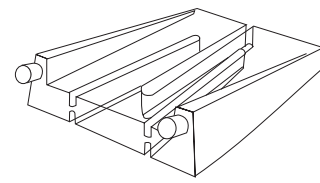

4 ResMed Passover

© 2005 ResMed Ltd.

C OTHER ACCESSORIES



1

3 m

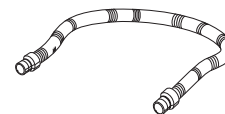

2

52 cm

© 2005 ResMed Ltd.

D SETTING UP THE VPAP

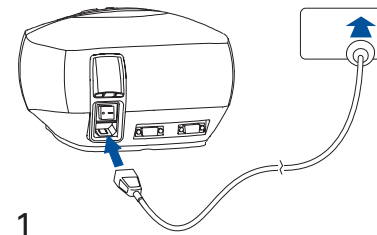

1

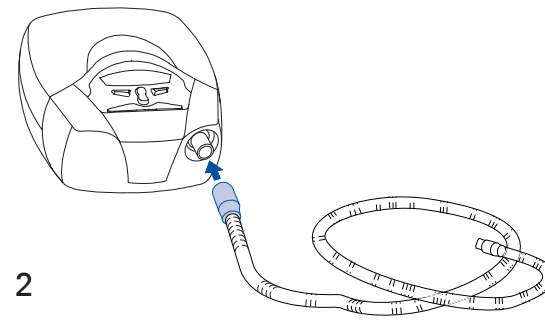

2

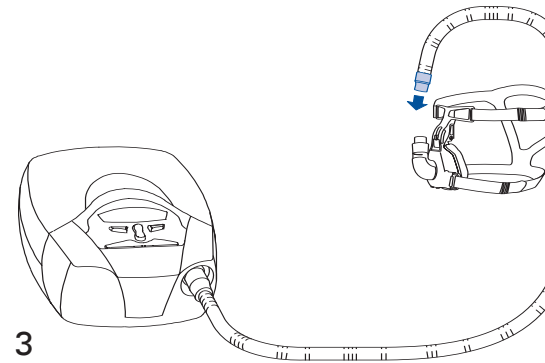

3

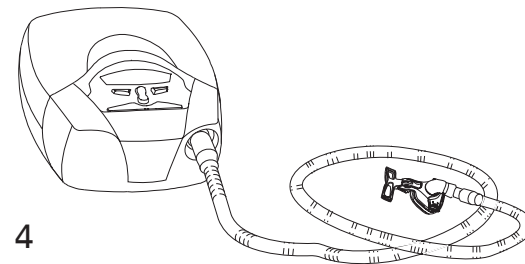

4

© 2005 ResMed Ltd.

E HUMIDAIRE 2i AND VPAP

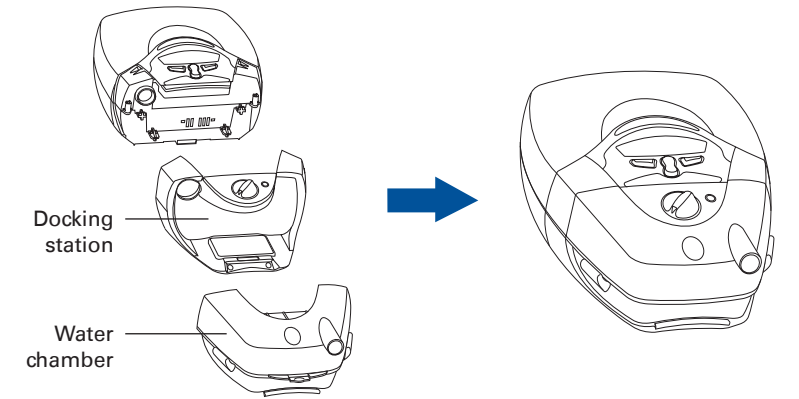

Docking station

Water chamber

© 2005 ResMed Ltd.

F HUMIDAIRE 2iC AND VPAP

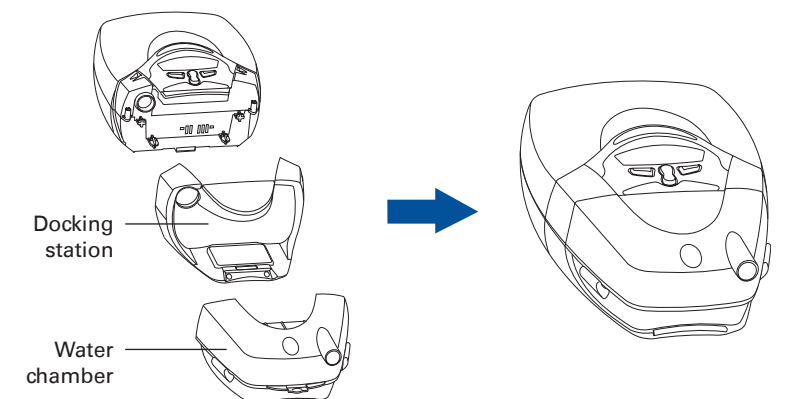

Docking station

Water chamber

© 2005 ResMed Ltd.

G ATTACHING A HUMIDAIRE HUMIDIFIER

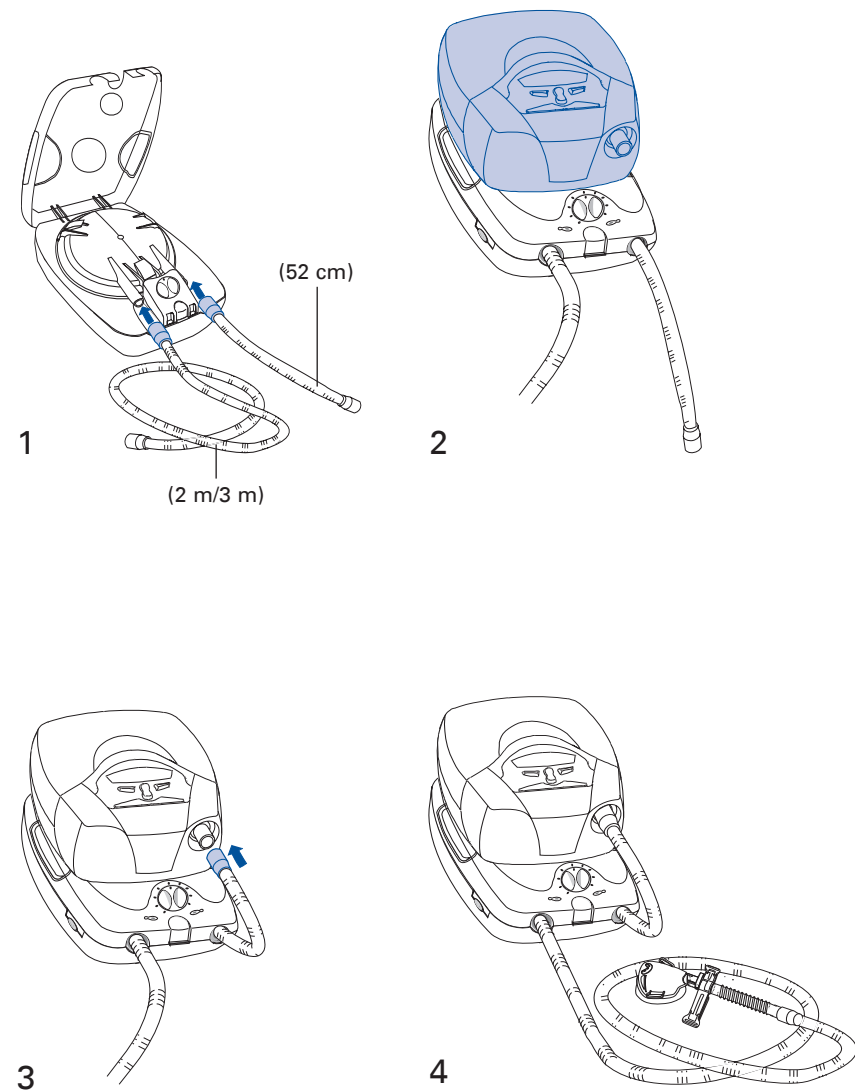

H ATTACHING A PASSEOVER HUMIDIFIER

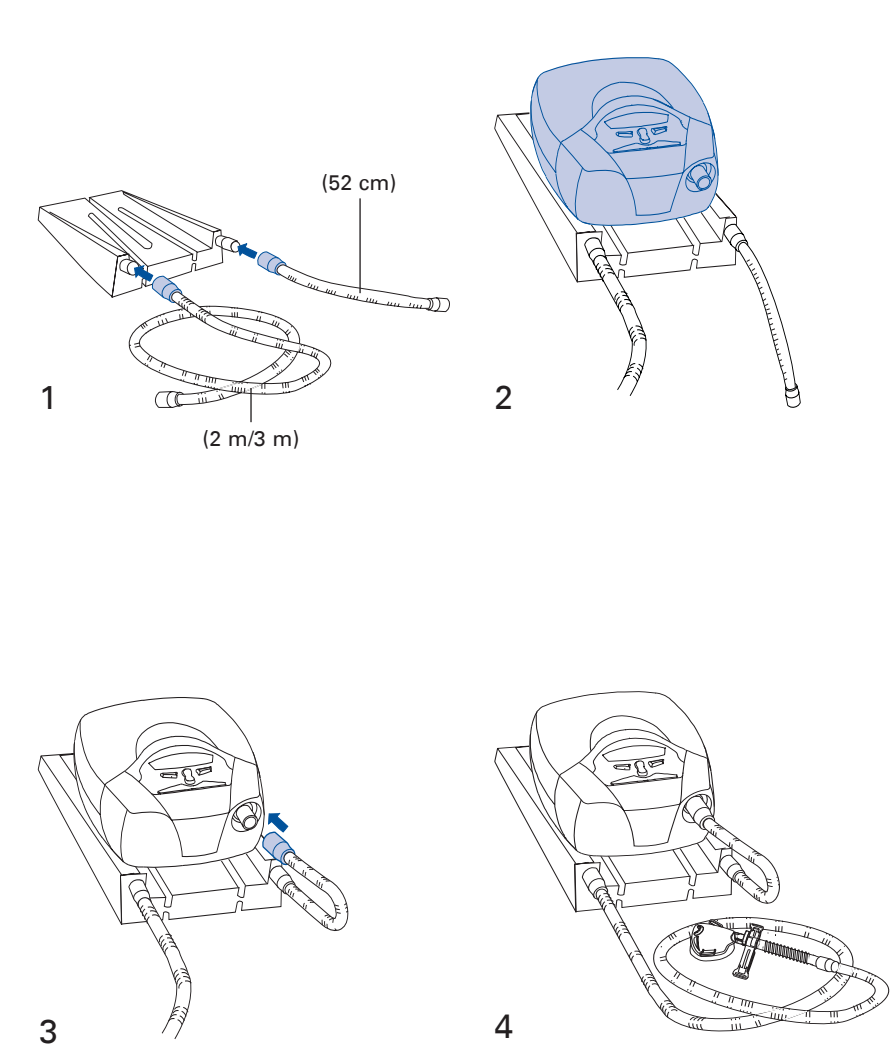

I REPLACING THE AIR FILTER

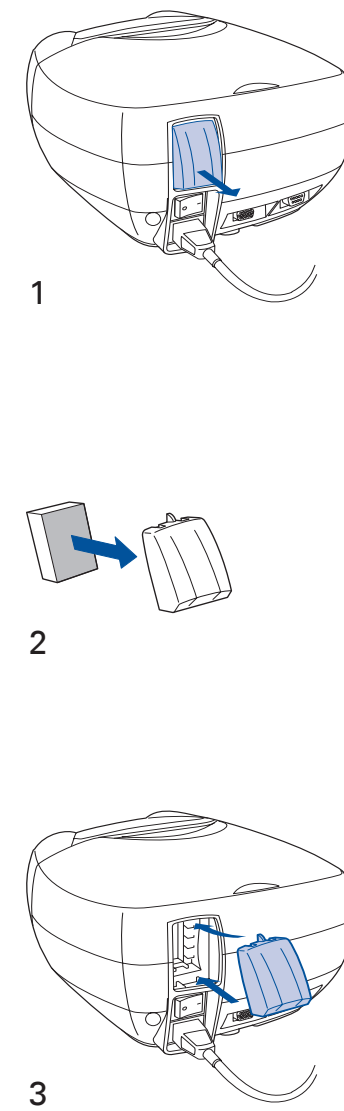

RESMED

**VPAP™ III & III ST
User Manual**

English

Manufactured by:

ResMed Ltd 1 Elizabeth MacArthur Drive Bella Vista NSW 2153 Australia
Tel: +61 (2) 8884 1000 or 1 800 658 189 (toll free) Fax: +61 (2) 8883 3114 Email: reception@resmed.com.au

Distributed by:

ResMed Corp 14040 Danielson Street Poway CA 92064-6857 USA
Tel: +1 (858) 746-2400 or 1-800-424-0737 (toll free) Fax: +1 (858) 746-2900 Email: reception@resmed.com

ResMed (UK) Limited 65 Milton Park Abingdon Oxfordshire OX14 4RX UK
Tel: +44 (1235) 862 997 Fax: +44 (1235) 831 336 Email: reception@resmed.co.uk

ResMed Asia Pacific Ltd 97 Waterloo Road North Ryde NSW 2113 Australia
Tel: +61 (2) 9886 5000 or 1 800 991 900 (toll free) Fax: +61 (2) 9889 1471 Email: reception@resmed.com.au

ResMed Austria GmbH Purtscherstraße 18, 9500 Villach Österreich
Tel: 43 (4242) 430 830 Fax: +43 (4242) 430 830-4 Email: reception@resmed.at

ResMed BV Nieuwe Parklaan 86, 2587 BV Den Haag Nederland
Tel: +31 (70) 358 6263 Fax: +31 (70) 358 4333 Email: receptiondh@resmed.nl

ResMed Finland Niittykatu 6 FIN 02200 ESPOO Suomi
Puh: +358 9 8676820 Faksi: +358 9 86768222 Sähköposti: reception@resmed.fi

ResMed GmbH & Co. KG Fraunhoferstraße 16, 82152 Martinsried Deutschland
Tel: +49 (0) 89/99 01-00 Fax: +49 (0) 89/99 01-10 55 Email: reception@resmed.de

ResMed Hong Kong Limited Room 1714, Miramar Tower 132-134 Nathan Road Tsim Sha Tsui Hong Kong
Tel: +852 2366 0707 Fax: +852 2366 4546 Email: reception@resmed.com.hk

ResMed Japan Nihonbashi Hisamatsu Bldg. 4F, 2-28-1 Nihonbashi-Hamacho, Chuo-Ku, Tokyo 103-0007, Japan
Tel: +81 (3) 3662 5056 Fax: +81 (3) 3662 5040

ResMed Malaysia Sdn Bhd Suite E-10-20, Plaza Mon't Kiara No. 2 Jalan 1/70C Mon't Kiara 50480 Kuala Lumpur Malaysia
Tel: +60 3 6201 7177 Fax: +60 3 6201 2177 Email: reception@resmed.com.my

ResMed NZ Ltd PO Box 51-048 Pakuranga Auckland New Zealand
Tel: +64 274 737 633 Fax: +64 9 239 0193 Email: reception@resmed.co.nz

ResMed SA Parc de la Bandonnière 2, rue Maurice Audibert 69800 Saint-Priest France
Tél. : +33 (0) 4 37 251 251 Fax : +33 (0) 4 37 251 260 Email: reception@resmed.fr

ResMed Singapore Pte Ltd 238A Thomson Road #12-03/04, Novena Square, Tower A Singapore 307684
Tel: +65 6284 7177 Fax: +65 6284 7787 Email: reception@resmed.com.sg

ResMed Spain SL C/Arturo Soria, 245 28033 Madrid España
Tel: +34 (93) 5908154 Fax: +34 (93) 5908153 Email: angelo@resmed.es

ResMed Sweden AB Industrigatan 2 S-461 37 Trollhättan Sverige
Tel: +46 520 420 110 Fax: +46 520 397 15 Email: reception@resmed.se

Labhardt AG Thannerstrasse 57 CH-4054 Basel Schweiz
Tel: +41 (061) 307 9711 Fax: +41 (061) 307 9722 Email: info@labhardt.ch

US DESIGNATED AGENT: ResMed Corp

EU AUTHORISED REPRESENTATIVE: ResMed (UK) Ltd

Internet: www.resmed.com

Protected by patents: AU 697652, AU 699726, AU 713679, EP 0661071, EP 0858352, US 4944310, US 5199424, US 5522382, US 6213119, US 6240921, US 6705315. Other patents pending.

Protected by design registrations: AU 147283, AU 147335, AU 147336, CH 128.709, CH 128.710, CH 128.711, CH 128.712, DE 40201723, DE 40202007, DE 40202008, DE 40202020, ES 153514, ES 153515, ES 153516, ES 153518, ES 156135, ES 156136, FR 02 1407, GB 3001791, GB 3001819, GB 3001820, GB 3001821, JP 1164087, JP 1164265, JP 1164266, JP 1164267, JP 3638613, SE 75598, SE 75599, SE 75600, SE 75715, US D467335, US D468011, US D476077, US D477868, US D487311, US D503796. Other designs pending.

VPAP, Activa, HumidAire, HumidAire 2i, Mirage, SmartStart, Smart Data, Ultra Mirage and Vista are trademarks of ResMed Ltd, and VPAP, Activa, HumidAire, HumidAire 2i, Mirage, SmartStart, Ultra Mirage and Vista are registered in U.S. Patent and Trademark Office.



Contents

Introduction	1
User/Owner Responsibility	1
Medical Information	1
What the VPAP III and VPAP III ST are Intended for	1
Contraindications	1
Warnings	2
Cautions	2
Adverse Effects	3
The VPAP System	5
Masks	5
Humidifiers	6
Accessories	6
Setting up the VPAP System	7
Setting Up The VPAP	7
Attaching a Humidifier	7
Using the LCD Screen and Keypad	10
Starting Treatment	13
Stopping Treatment	14
Using the HumidAire 2i Warm-Up Feature	14
Using the Mask-Fitting Feature	14
Cleaning and Maintenance	17
Daily Cleaning	17
Weekly Cleaning	17
Periodic Cleaning	17
Replacing the Air Filter	18
Servicing	18
How to Use the VPAP Menus	19
Ramp Screen	19
How to Use the Standard Menu	19
How to Use the Detailed Menu (if enabled by your clinician)	20
Menu Functions (Detailed menu only)	22
Treatment Screens	26
Helpful Hints	29
Using a Battery and an Inverter	29
Troubleshooting	31
System Specifications	35

Limited Warranty	43
Index	45

Introduction

The VPAP™ III and VPAP III ST are bilevel pressure support ventilators specifically designed for non-invasive mask ventilation.

This user manual contains the information you need for the correct use of your VPAP.

User/Owner Responsibility

The user or owner of this system shall have sole responsibility and liability for any injury to persons or damage to property resulting from:

- operation which is not in accordance with the operating instructions supplied
- maintenance or modifications carried out unless in accordance with authorised instructions and by authorised persons.

Please read this manual carefully before use.

This manual contains special terms and icons that appear in the margins to draw your attention to specific and important information.

- Warning alerts you to possible injury.
- Caution explains special measures for the safe and effective use of the device.
- Note is an informative or helpful note.

Medical Information

What the VPAP III and VPAP III ST are Intended for

The VPAP III and VPAP III ST systems are intended to provide non-invasive ventilation for patients with respiratory insufficiency or obstructive sleep apnoea (OSA), in the hospital or home.

Contraindications

The VPAP should not be used if you have an insufficient respiratory drive to endure brief interruptions in non-invasive ventilation therapy. The VPAP is not a life support ventilator and may stop operating with power failure or in the unlikely event of certain fault conditions.

If you have any of the following conditions, tell your doctor before using the VPAP:

- acute sinusitis or otitis media
- epistaxis causing a risk of pulmonary aspiration

- conditions predisposing to a risk of aspiration of gastric contents
- impaired ability to clear secretions
- hypotension or significant intravascular volume depletion
- pneumothorax or pneumomediastinum
- recent cranial trauma or surgery.

Warnings

- The entire manual should be read before using the VPAP.
- Advice contained in this manual should not supersede instructions given by the prescribing physician.
- The VPAP should be used with masks and accessories recommended by ResMed or the prescribing physician. Use of incorrect masks and accessories may adversely affect the function of the VPAP.
- The VPAP is designed for use with masks that allow exhaled gases to be flushed out through vent holes. Exhaled gases will be rebreathed if the mask is worn with the machine turned off, or the vent holes are occluded. If this occurs over prolonged periods, suffocation may occur.
- In the event of power failure or machine malfunction, remove the mask.
- The VPAP can be set to deliver pressures up to 25 cm H₂O. In the unlikely event of certain fault conditions, pressures up to 40 cm H₂O are possible.
- The VPAP is not suitable for use in the vicinity of flammable anaesthetics.
- The VPAP should not be used with anaesthetised patients, whose breathing depends on artificial ventilation.
- If oxygen is used with the VPAP, the oxygen flow should be stopped when the device is not operating. If oxygen flow continues when the device is not operating, oxygen may accumulate within the device and create a risk of fire.
- Do not use the VPAP if there are obvious external defects, unexplained changes in performance or unusual noises.
- Do not open the VPAP case. There are no user serviceable parts inside. Repairs and internal servicing should only be performed by an authorised service agent.

Cautions

- At low EPAP pressures, the flow through the mask vent holes may be inadequate to clear all exhaled gases, and some rebreathing may occur.
- The air flow for breathing produced by this device can be as much as 6°C higher than the temperature of the room. Caution should be exercised if the room temperature is warmer than 32°C.

Note: *The above are general warnings and cautions. Further specific warnings, cautions and notes appear next to the relevant instructions in the manual.*

Adverse Effects

You should report unusual chest pain, severe headache or increased breathlessness to your physician. An acute upper respiratory tract infection may require temporary discontinuation of treatment.

The following side effects may arise during the course of therapy with the VPAP:

- drying of the nose, mouth or throat
- bloating
- ear or sinus discomfort
- eye irritation
- mask-related skin irritations
- chest discomfort.

The VPAP System

Please refer to the illustrations in section **A** of the illustration sheet.

Please identify and familiarise yourself with the following components of the VPAP unit:

- VPAP front view (**A-1**)
- VPAP rear view (**A-2**)
- Power cord (**A-3**)
- Carry bag (**A-4**)
- 2 m air tubing (**A-5**).



WARNING

- Do not connect any device to the auxiliary port. Although your health care provider may connect specially designed devices to the auxiliary port of the VPAP unit, connection of other devices could result in injury, or damage to the unit.
- In the home environment, the only device that may be connected to the communications port is a modem that is locally approved. Locally approved modems may also be connected in the clinical environment.
- In the clinical environment any PC that is used with the VPAP system must be at least 1.5 m away from, or at least 2.5 m above the patient. It must also comply with IEC 60950 or equivalent.

Masks

You will also need a **ResMed mask system** (supplied separately).

The following ResMed mask systems are recommended for use with the VPAP:

Nasal Masks

- Ultra Mirage™ Nasal Mask
- Mirage™ Nasal Mask
- Mirage Activa™ Nasal Mask
- Mirage Vista™ Nasal Mask
- Modular Nasal Mask.

Full Face Masks

- Mirage™ Full Face Mask
- Mirage™ Full Face Mask Series 2
- Ultra Mirage™ Full Face Mask.

To select the appropriate setting for your mask, see “Settings for Mask Types” on page 23.

Notes:

- *ResMed VPAP devices have been designed and manufactured to provide optimum performance using ResMed vented mask systems. While other vented mask systems may be used, performance and data outputs may be affected. To select an appropriate setting for another mask system, find the closest match to a ResMed mask in Table 3 on page 23.*
- *Not all masks are available in all regions.*

Humidifiers

*Please refer to the illustrations in section **B** of the illustration sheet.*

A humidifier may be required if you are experiencing dryness of the nose, throat or mouth. The VPAP is compatible for use with the following humidifiers:

- HumidAire 2i™ heated humidifier (**B-1**)
- HumidAire 2iC™ passover humidifier (**B-2**)
- HumidAire™ heated humidifier (**B-3**)
- ResMed Passover humidifier (**B-4**).

**WARNING**

Only the HumidAire 2i, HumidAire 2iC, HumidAire heated humidifier and the ResMed Passover are compatible for use with the VPAP. Please refer to Warnings on page 2.

Accessories

*Please refer to the illustrations in section **C** of the illustration sheet.*

The following accessories may be purchased separately:

- 3 m air tubing (**C-1**)
- Medium (52 cm) air tubing for the HumidAire and ResMed Passover humidifiers (**C-2**).

Note: *ResMed regularly releases new products. Please check our website at <www.resmed.com>.*

Setting up the VPAP System

Please refer to the illustrations in section **D** of the illustration sheet.

Setting Up The VPAP

- 1 Place the VPAP unit on a flat surface near the head of your bed. If the unit is placed on the floor, ensure that the area is free from dust and clear of bedding, clothes or any other objects that could block the air inlet.



CAUTION

Be careful not to place the device where it can be bumped or where someone is likely to trip over the power cord.

- 2 Connect the power cord to the socket at the rear of the flow generator. Plug the other end of the power cord into a power outlet (**D-1**).



WARNING

- Make sure the power cord and plug are in good condition and the equipment is not damaged.
- The air filter cover protects the device in the event of accidental liquid spillage onto the device. Ensure that the air filter and air filter cover are fitted at all times.

- 3 Connect one end of the air tubing firmly onto the air outlet of the unit (**D-2**).



WARNING

Only ResMed air tubing should be used with your flow generator. A different type of air tubing may alter the pressure you actually receive and reduce the effectiveness of your treatment.

- 4 Assemble your mask system according to the mask user instructions.

- 5 Connect your mask system to the free end of the air tubing (**D-3**).
The VPAP system is now assembled (**D-4**). To start treatment, see "Starting Treatment" on page 13.

Attaching a Humidifier



WARNING

When using a humidifier, position it lower than you, and at the same level or lower than the VPAP.

Attaching a HumidAir 2i Humidifier

Please refer to the illustrations in section **E** of the illustration sheet.

The HumidAir 2i attaches to the front of the VPAP to provide heated humidification. No other accessories are required for its use. The VPAP automatically detects the presence of the HumidAir 2i. No menu changes are required. Please refer to the *HumidAir 2i User's Manual* for details.

Attaching a HumidAir 2iC Humidifier

Please refer to the illustrations in section **F** of the illustration sheet.

The HumidAir 2iC attaches to the front of a VPAP unit to provide passover humidification. No other accessories are required for its use. Please refer to the *HumidAir 2iC User's Manual* for details.

Note: You must activate the humidifier option in the menus if you are using a HumidAir, HumidAir 2iC or Passover humidifier.

Attaching a HumidAir Humidifier

Please refer to the illustrations in section **G** of the illustration sheet.

Medium size (52 cm) air tubing is a necessary accessory for connecting the VPAP unit to the HumidAir humidifier.

To set up the VPAP with the HumidAir:

1. Fill the HumidAir with water as described in the humidifier manual.
2. Place the filled water chamber inside the HumidAir. Connect the medium (52 cm) air tubing to the right connector port, and the long air tubing (2 m or 3 m) to the left connector port on the humidifier (**G-1**). Close the HumidAir lid.
3. Place the VPAP on top of the HumidAir (**G-2**). Do not place the VPAP unit underneath the humidifier. (This is to avoid water spilling into the unit.)
4. Connect the free end of the medium air tubing to the air outlet of the VPAP (**G-3**).
5. Connect the mask system to the free end of the long air tubing. The final assembly should look like figure **G-4**.
6. Plug the HumidAir power cord into a power outlet.
7. If the VPAP is not already plugged in, see Step 2 on page 7.

WARNING

Make sure that the power cord and plug are in good condition and the equipment is not damaged.

8. Navigate to the humidifier setting (if available) in the VPAP menu and select "HUMIDAIRE". See "How to Use the Detailed Menu (if enabled by your clinician)" on page 20.

The VPAP is now ready for use with the HumidAire. To start treatment, see “Starting Treatment” on page 13.

Attaching a Passover Humidifier

*Please refer to the illustrations in section **H** of the illustration sheet.*

Medium size (52 cm) air tubing is a necessary accessory for connecting the VPAP unit to the ResMed Passover humidifier.

To set up the VPAP with the ResMed Passover:

1. Fill the Passover with water as described in the humidifier manual.
2. Connect the medium (52 cm) air tubing to the right connector port, and the long air tubing (2 m or 3 m) to the left connector port on the humidifier (**H-1**).
3. Place the VPAP on top of the Passover (**H-2**). Do not place the VPAP unit underneath the humidifier. (This is to avoid water spilling into the unit.)
4. Connect the free end of the medium air tubing to the air outlet of the VPAP (**H-3**).
5. Connect the mask system to the free end of the long air tubing. The final assembly should look like figure **H-4**.
6. If the VPAP is not already plugged in, see Step 2 on page 7.



WARNING

Make sure that the power cord and plug are in good condition and the equipment is not damaged.

7. Navigate to the humidifier setting (if available) in the VPAP menu and select "PASSOVER". See “How to Use the Detailed Menu (if enabled by your clinician)” on page 20.

The VPAP is now ready for use with the ResMed Passover. To start treatment, see “Starting Treatment” on page 13.

Using the LCD Screen and Keypad

The control panel of the VPAP includes an LCD screen and keypad.

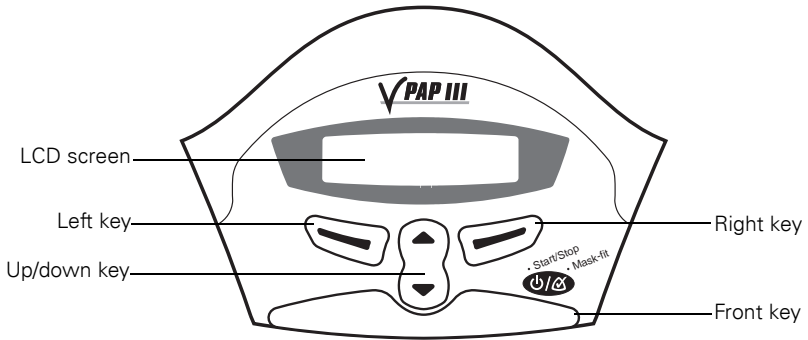

LCD Screen



The LCD screen displays the menus and treatment screens.





To assist you in adjusting the VPAP, the keypad and LCD are equipped with a backlight. The LCD backlight comes on when the unit is turned on or when you press a key, and turns off after two minutes.

Keypad Keys

The VPAP keypad has the following keys:

Key	Function
Front 	<ul style="list-style-type: none">Starts or stops treatment.Extended hold for at least three seconds starts the Mask-Fitting feature.
Up/Down 	<ul style="list-style-type: none">Allows you to scroll through the VPAP menus, submenus and setting options.

Key	Function
Left (green) 	<ul style="list-style-type: none">• Performs the function indicated by the guiding text displayed above it on the LCD screen. Guiding text includes menu, enter, change and apply.
Right (red) 	<ul style="list-style-type: none">• Performs the function indicated by the guiding text displayed above it on the LCD screen. Guiding text includes exit and cancel.

The keypad backlight is on at all times when the VPAP is powered.

Starting Treatment

The VPAP unit should be assembled beside your bed with the air tubing and mask system connected. See “Setting Up The VPAP” on page 7.

- 1 Turn the main power switch at the back of the unit to on (I).

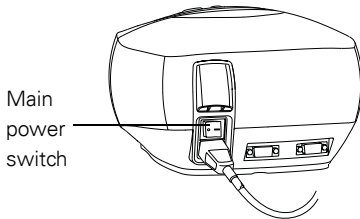

When the VPAP is turned on, a welcome message is displayed on the LCD screen. The VPAP (or Ramp) screen then appears.

Note: If you have the HumidAire 2i attached, see “Using the HumidAire 2i Warm-Up Feature” on page 14.

- 2 Fit your mask as described in the mask user instructions.
- 3 Lie down and arrange the air tubing so that it is free to move if you turn in your sleep.



CAUTION

- Do not leave long lengths of air tubing around the top of your bed. It could twist around your head or neck while you are sleeping.
- Make sure the area around the flow generator is dry and clean. It should also be clear of bedding, clothes and other potential blockages.

- 4 To start treatment, press the **Front** key
or

if your clinician has enabled the SmartStart function, simply breathe into the mask and treatment will begin.

After starting treatment, you can display one of the treatment screens described in “Treatment Screens” on page 26.

Ramp time

Ramp time is a feature which can be enabled by your clinician. If you have difficulty falling asleep with full pressure, select a ramp time. The airflow will start very gently while you fall asleep. The pressure will slowly increase to full operating pressure over the selected ramp time. The clinician has set a maximum ramp time; you may select any value up to the maximum.

To select a ramp time, see “Ramp Screen” on page 19.

Stopping Treatment

To stop treatment at any time, remove your mask and press the **Front** key **or**

if your clinician has enabled the SmartStart function, simply remove your mask and treatment will end (SmartStop is not applicable with the "Mir Full" mask setting).

Using the HumidAire 2i Warm-Up Feature

If using a HumidAire 2i with the VPAP, you can use the Warm-Up feature to pre-heat the water in the humidifier prior to starting treatment.

After stopping treatment, the VPAP will continue to blow air gently to assist cooling of the heater plate.

See the *HumidAire 2i User's Manual* for further details.

Using the Mask-Fitting Feature

The VPAP Mask-Fitting feature can be used to help you fit your mask properly. The mask-fitting feature delivers air pressure for a three-minute period, prior to starting treatment, for checking and adjusting your mask fit to minimise leaks. If a Ramp time is selected, the mask can be adjusted at a pressure closer to the prescribed pressure. To use the mask-fitting feature:

1. Fit your mask as described in the user instructions.
2. Hold down the **Front** key for at least three seconds until air pressure delivery starts.

The following display will appear on the LCD screen indicating that the Mask-Fitting feature is in operation. The flow generator will ramp to the Mask-Fit pressure and will remain at this pressure for three minutes. A Mask-Fit star rating is also displayed. See "Definitions of Mask-Fit Star Rating" on page 15.

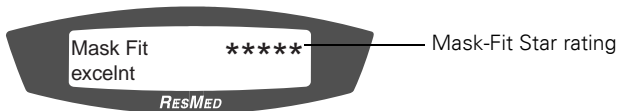

Notes:

- The Mask-Fit star rating display disappears after three minutes.
- The Mask-Fitting feature can only be started from the VPAP (or Ramp) screen.
- The Mask-Fit pressure is the set treatment pressure or 10 cm H₂O, whichever is greater.

3. Adjust your mask, mask cushion and headgear until you have a secure and comfortable fit.

Once you have a secure and comfortable fit, check your Mask-Fit star rating on the LCD screen. Definitions of the Mask-Fit star ratings are presented in Table 1.

Note: *If there is another person nearby to check your Mask-Fit star rating, you can adjust your mask, mask cushion and headgear while lying down.*

4. After three minutes, treatment will begin.

- If you do not wish to wait three minutes, hold down the **Front** key for at least three seconds and treatment will begin immediately.
- If you press the **Front** key for less than three seconds, the unit will return to standby mode (the VPAP or Ramp screen is displayed).

Table 1: Definitions of Mask-Fit Star Rating

Star rating	Definition
*****	Excellent
****_	Very good
***__	Good
**___	Adjust mask
*____	Adjust mask
HIGH LEAK	Adjust mask

Cleaning and Maintenance

You should regularly carry out the cleaning and maintenance described in this section.

Daily Cleaning

Mask

Clean the mask according to the instructions supplied with the mask.

Air tubing

Disconnect the air tubing from the VPAP unit (and humidifier, if used) and hang the tubing and mask in a clean, dry place until next use.



CAUTION

Do not hang the air tubing in direct sunlight as the tubing may harden over time and eventually crack.

Humidifier

If you are using a humidifier, clean it according to the instructions in the humidifier user manual.

Weekly Cleaning

1. Remove the air tubing from the VPAP unit *and* the mask.
2. Wash the air tubing in warm water using mild detergent. Rinse thoroughly, hang and allow to dry.
3. Before next use, assemble the mask and headgear according to the user instructions.
4. Reconnect the air tubing to the air outlet and mask.



CAUTION

- Do not use bleach, chlorine-, alcohol- or aromatic-based solutions (including all scented oils), moisturising or antibacterial soaps to clean the air tubing or the VPAP. These solutions may cause hardening and reduce the life of the product.
- Do not hang the air tubing in direct sunlight as the tubing may harden over time and eventually crack.

Periodic Cleaning

1. Clean the exterior of the VPAP unit with a damp cloth and mild liquid soap.
2. Inspect the air filter to check if it is blocked by dirt or contains holes. See "Replacing the Air Filter" on page 18.



WARNING

Beware of electric shock. Do not immerse the flow generator or power cord in water. Always unplug the flow generator before cleaning and be sure that it is dry before reconnecting.



CAUTION

Do not attempt to open the VPAP. There are no user serviceable parts inside. Repairs and internal servicing should only be performed by an authorised service agent.

Replacing the Air Filter

*Please refer to the illustrations in section **A** of the illustration sheet.*

Inspect the air filter every month to check if it is blocked by dirt or contains holes. With normal use of a VPAP unit, the air filter needs to be replaced every six months (or more often if your unit is in a dusty environment). To replace the air filter:

1. Remove the air filter cover at the back of the VPAP (**I-1**).
2. Remove and discard the old air filter.
3. Insert a new filter with the blue tinted side facing out (**I-2**).
4. Replace the air filter cover (**I-3**).



WARNING

Do not wash the air filter. The air filter is not washable or reusable.

***Note:** The air filter should be inspected once a month.*

Servicing

This product (VPAP III/VPAP III ST) should be inspected by an authorised ResMed service centre 5 years from the date of manufacture. Prior to this, the device is intended to provide safe and reliable operation provided that it is operated and maintained in accordance with the instructions provided by ResMed. Applicable ResMed warranty details are provided with the device at the time of original supply. Of course, as with all electrical devices, if any irregularity becomes apparent, you should exercise caution and have the device inspected by an authorised ResMed service centre.

If you feel that your unit is not performing properly, see “Troubleshooting” on page 31.



CAUTION

Inspection and repair should only be performed by an authorised agent. Under no circumstances should you attempt to service or repair the flow generator yourself.

How to Use the VPAP Menus

The VPAP unit provides a set of functions arranged in menus and submenus. Via the LCD screen, the menus and submenus allow you to view and change the settings for a particular function. You can access the menus regardless of whether the VPAP is in standby mode or delivering therapy.

Your clinician has preset the menu to either a standard view or a detailed view. Both of these menus are explained below.

When the VPAP is turned on, a Welcome screen is displayed. After the device self-checks are complete, the VPAP (or Ramp) screen appears.

Ramp Screen

If your clinician has set a maximum ramp time, the Ramp screen is displayed after the Welcome screen. On the Ramp screen, you can immediately set a ramp time. Ramp time is the period during which the pressure increases from a low pressure to the prescribed treatment pressure. See “Ramp time” on page 13.

Ramp time can be altered in five minute increments (from OFF to a maximum ramp time set by your clinician) by using the **Up/Down** key.

How to Use the Standard Menu

The standard menu allows you to view details about the time used and the current software version of your VPAP. The Used (time) screen displays the total number of hours for which the device has been used. It also displays the number of days the VPAP was used out of the total number of days available for use.

Figure 1 summarises the VPAP standard menu series.

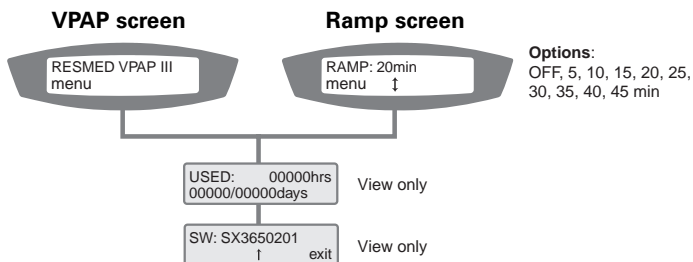

Figure 1: VPAP Standard Menu Series

- To access the VPAP menus:
Press the **Left** key (menu) while the VPAP (or Ramp) screen is displayed.
- To scroll through items within the menu:
Press the **Up/Down** key
- To exit out of the menu:
Press the **Right** key (exit)

How to Use the Detailed Menu (if enabled by your clinician)

The detailed menu allows you to view and change settings such as mask type, tube length and the humidifier used. You can also view the serial number and current software version of your VPAP.

Figure 2 summarises the VPAP detailed menu series.

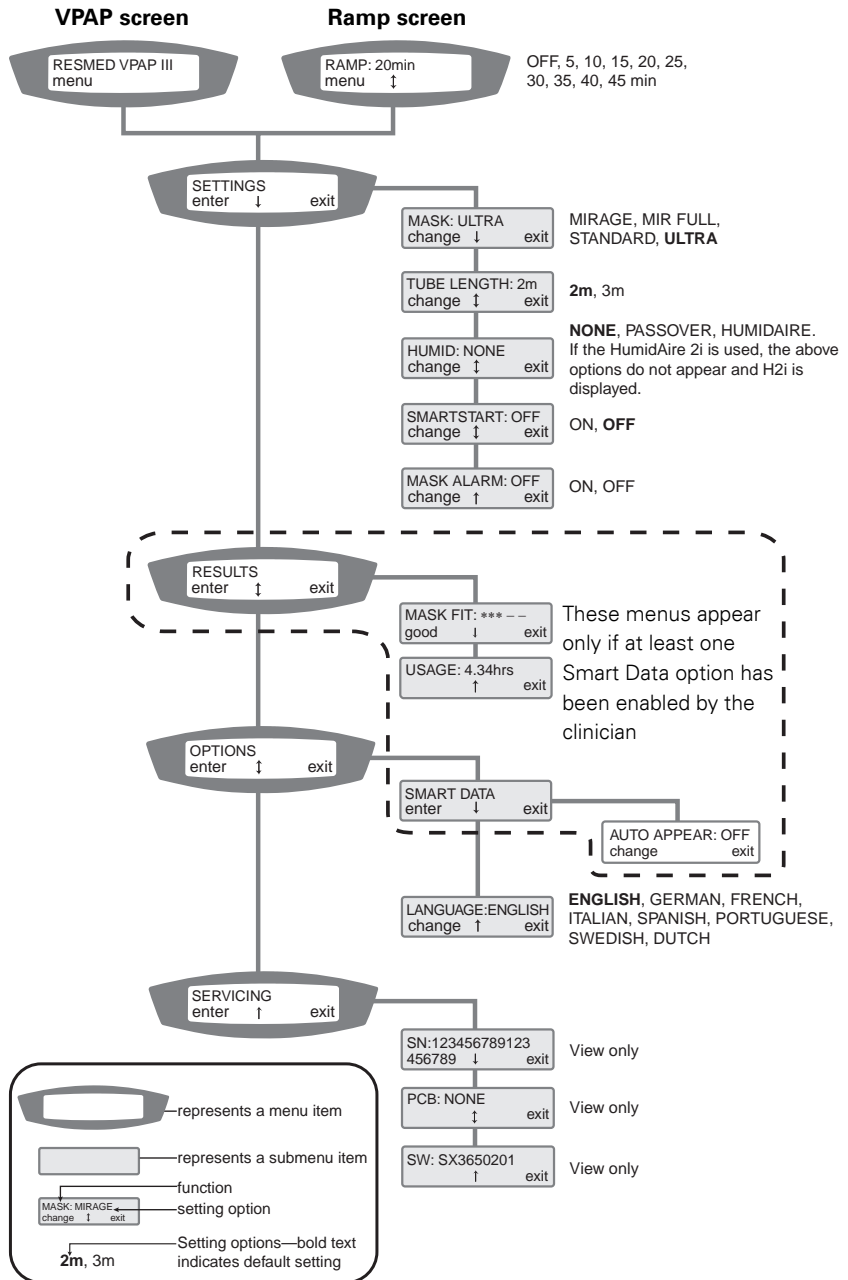

Figure 2: VPAP Detailed Menu Series (if enabled by your clinician)

- To access the VPAP menus:
Press the **Left** key (menu) while the VPAP (or Ramp) screen is displayed.
- To scroll through items within a menu or submenu:
Press the **Up/Down** key
- To enter a submenu:
Press the **Left** key (enter).
- To change a setting option for a function:
 1. Press the **Left** key (change)
 2. Press the **Up/Down** key until the desired setting option appears.
 3. Press the **Left key** (apply) to select the setting option.
- To exit without changing options:
Press the **Right** key (cancel)
- To exit out of a menu or submenu:
Press the **Right** key (exit)

Note: You can return to the VPAP (or Ramp) screen at any time by holding the Right key for at least three seconds.

Menu Functions (Detailed menu only)

The VPAP menu functions are summarised in Tables 2–6 below with a brief description of what each function does and the available setting options. To access these functions, see “How to Use the Detailed Menu (if enabled by your clinician)” on page 20.

Settings Menu

The Settings Menu allows you to view and change certain operating features of the VPAP unit.

Table 2: Settings Menu Functions

Function	Default	Function Description	Setting Options
Mask	ULTRA	Selects your mask type.	See “Settings for Mask Types” on page 23 for details.
Tube Length	2m	Selects the length of air tubing connecting your mask to the VPAP.	2m / 3m

Function	Default	Function Description	Setting Options
Humidifier	NONE	Selects the type of humidifier to be used with the VPAP.	NONE, PASSOVER, HUMIDAIRE If the HumidAire 2i is used, the above setting options do not appear and H2i is displayed.
SmartStart™	OFF	Turns the SmartStart function on or off. See "SmartStart™" on page 23.	ON/OFF
Mask Alarm	ON (VPAP III ST); OFF (VPAP III)	Turns the Mask Alarm signal on or off. If enabled, the Mask Alarm feature will alert you when a high mask leak is detected. An audible tone will sound and a high leak message will appear on the LCD screen.	ON/OFF

SmartStart™

The VPAP has a function called SmartStart which can be enabled by your clinician. If SmartStart is enabled, VPAP will start automatically when you breathe into the mask and will stop automatically when you take your mask off. This means you do not have to press the **Front** key to begin or end treatment.

Note: If you select "Mir Full" as the mask option, SmartStop is automatically disabled. SmartStart may not work with an Ultra Mirage Full Face Mask due to safety features of the mask.

When Mask Alarm is set to ON, SmartStart/Stop automatically reverts to OFF. SmartStop cannot be used with Mask Alarm because if a high leak occurs, SmartStop will stop treatment before the Mask Alarm signal is activated.

Settings for Mask Types

The following table shows the setting that should be selected for each mask type.

Table 3: Settings for mask types

Settings	Mask
MIRAGE	Mirage Nasal Mask
ULTRA	Ultra Mirage Nasal Mask

Settings	Mask
STANDARD	Mirage Activa Nasal Mask Mirage Vista Nasal Mask Modular Nasal Mask
MIR FULL	Mirage Full Face Mask Mirage Full Face Mask Series 2 Ultra Mirage Full Face Mask

Results Menu

Note: This menu appears only if at least one Smart Data™ option has been enabled by the clinician. See the VPAP III Smart Data Diary for further details.

Table 4: Results Menu

Function	Function Description	Setting Options
Mask Fit (Smart Data)	Displays a star rating corresponding to the mask leak from the previous session. See Table 1 on page 15 for mask-fit star rating description.	View only
Usage (Smart Data)	Displays usage hours from the previous session. See Table 1 on page 15 for mask-fit star rating description.	View only

Options Menu

Table 5: Options Menu

Function	Default	Function Description	Setting Options
Smart Data –Auto Appear	OFF	The Smart Data menu is displayed only if one or more of the options have been set to ON by the clinician. If Auto Appear is set to ON, the Smart Data screens are displayed upon powering up of the device. If Auto Appear is set to OFF, Smart Data is displayed in the Results menu only.	ON/OFF
Language	English	Selects the language the VPAP uses for all its display text. English is the default language.	English, German, French, Italian, Spanish, Portuguese, Swedish, Dutch.

Servicing Menu

Table 6: Servicing Menu

Function	Function Description	Setting Options
Serial Number (SN)	Displays the serial number for the VPAP.	View only
Printed Circuit Board (PCB)	Displays the printed circuit board number.	View only
Software *	Displays the current software version installed in the VPAP.	View only

* This item also appears in the Standard Menu.

Treatment Screens

After starting treatment, you can display one of the treatment screens below. Press the **Up/Down** key to switch between views.

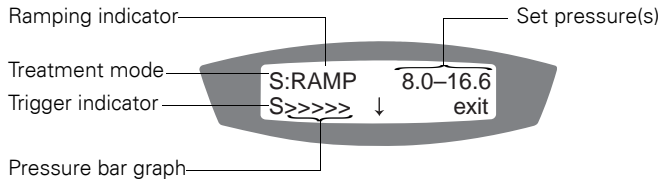

Figure 3: Treatment screen 1

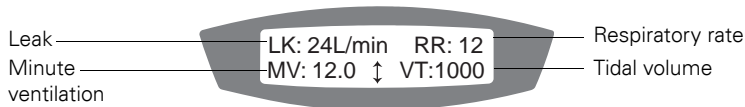

Figure 4: Treatment screen 2

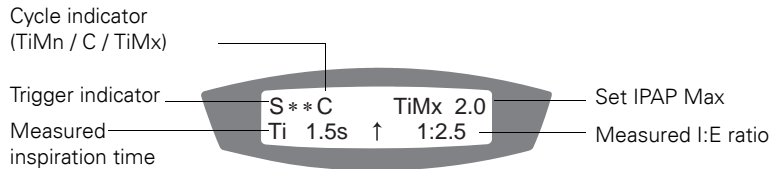

Figure 5: Treatment screen 3

The treatment screens contain the following information:

Treatment mode: Mode of treatment set by your clinician. Options include: CPAP, Spontaneous, Spontaneous/Timed (VPAP III ST) and Timed (VPAP III ST).

Ramping indicator: Appears if the VPAP is in ramp mode. This disappears once the ramp time has elapsed.

Set pressure(s): In CPAP mode, this displays the set treatment pressure (units: centimetres of water). In other modes, it is exhalation and inhalation pressures (units: centimetres of water).

Trigger indicator: How the VPAP changes the pressure when you are inhaling. "S" (Spontaneous) indicates a patient triggered change and "T" (Timed) indicates a device triggered change.

Pressure bar graph: Graphical display of the changing pressure.

Leak: Current mask leak (units: litres per minute).

Respiratory rate: Number of breaths per minute.

Minute ventilation: Volume of air inhaled per minute (units: litres per minute). It is the product of respiratory rate and tidal volume.

Tidal volume: Volume of air inhaled per breath (units: millilitres per breath).

Cycle indicator: How the VPAP changes the pressure when you are exhaling. "C" indicates a patient cycled change; "TiMn" and "TiMx" indicates a device cycled change.

Measured inspiration time: The average inhalation time measured by the VPAP.

Set IPAP Max: The maximum inhalation time set by your clinician.

Measured I:E ratio: The inhalation to exhalation ratio measured by the VPAP.

Helpful Hints

Starting out

Mouth Leaks

If using a nasal mask, try to keep your mouth closed during treatment. Air leaks from your mouth can decrease the effectiveness of your treatment. If mouth leaks are a problem, a full face mask or chin strap may help. Contact your clinician or equipment supplier for further details.

Mask Fitting

The flow generator delivers the most effective treatment when the mask is well fitted and comfortable. Treatment can be affected by leaks, so it is important to eliminate any leaks that may arise.

If you have problems trying to get a comfortable mask fit, contact your sleep clinic or equipment supplier. You may benefit from a different size or style of mask.

You can also use the Mask-Fitting feature to help you fit your mask properly. See “Using the Mask-Fitting Feature” on page 14.

Before wearing your mask, wash your face to remove excess facial oils. This will allow a better fit and prolong the life of the mask cushion.

Nasal Irritation

Dryness

You may experience dryness of the nose, mouth and/or throat during the course of treatment, especially during winter. In many cases, a humidifier may resolve this discomfort. Contact your clinician for advice.

Runny or Blocked Nose

You may experience sneezing and/or a runny or blocked nose during the first few weeks of treatment. In many cases, nasal irritation can be resolved with a humidifier. Consult your clinician for advice.

Travelling with the VPAP

International Use

Your VPAP flow generator has an internal power adapter that enables it to operate in other countries. It will operate on power supplies of 100–240V and 50–60Hz. No special adjustment is necessary, but you may need a plug adapter for the power outlet.

Using a Battery and an Inverter

Your VPAP can be powered by a battery using an inverter. We recommend a 12V or 24V deep-cycle battery, and any CE or UL marked inverter with a minimum continuous output power rating of 200W.

Note: When using the VPAP with a HumidAire 2i, use a pure sine wave inverter **not** a modified sine wave inverter.

Please refer to the VPAP III battery power guide for battery capacities and further details.

Troubleshooting

If there is a problem, try the following suggestions. If the problem cannot be solved, contact your equipment supplier or ResMed. Do not attempt to open the unit.

Problem	Possible Cause	Solution
<i>No display.</i>	Power not connected or switch at back is not on.	Ensure the power cable is connected and that the switch at the back of the unit is in the ON position.
<i>Insufficient air delivered from the VPAP.</i>	Ramp Time is in use.	Wait for air pressure to build up.
	Air filter is dirty.	Replace air filter.
	Air tubing is kinked or punctured.	Straighten or replace tubing.
	Air tubing not connected properly.	Check air tubing.
	Mask and headgear not positioned correctly.	Adjust position of mask and headgear.
	Plug(s) missing from access port(s) on mask.	Replace plug(s).
	Pressure required for treatment may have changed.	See your clinician to adjust the pressure.
<i>The VPAP does not start when you breathe into the mask.</i>	Power cord not connected properly.	Connect power cord firmly at both ends.
	Power outlet may be faulty.	Try another power outlet.
	The VPAP unit not switched on.	Switch power switch at rear of the VPAP to ON.
	SmartStart not on.	Enable SmartStart.
	Mask Alarm has been enabled; SmartStart has automatically been disabled.	Disable Mask Alarm to enable SmartStart.

Problem	Possible Cause	Solution
	Breath is not deep enough to trigger SmartStart.	Take a deep breath in and out through the mask.
	There is excessive leak.	Adjust position of mask and headgear. Plugs may be missing from ports on mask. Replace them. Air tubing not connected properly. Connect firmly at both ends. Air tubing kinked or punctured. Straighten or replace.
<i>VPAP unit does not stop when you remove your mask.</i>	SmartStart/Stop is disabled.	Enable SmartStart/Stop.
	Use of an Ultra Mirage Full Face Mask.	SmartStop does not work with a full face mask.
<i>SmartStart is enabled but the flow generator does not stop automatically when you remove your mask.</i>	Incompatible humidifier or mask system being used.	Use only equipment as recommended and supplied by ResMed.
<i>Display error message: Check tube!! Key if done</i>	The air tubing is loose.	Check that the air tubing is connected securely to your mask and the air outlet on the front of the VPAP. To clear the error message, press any key on the VPAP keypad.
<i>Displays error message: SYSTEM ERROR Call service!</i>	Component failure.	Return your VPAP for servicing.

Problem	Possible Cause	Solution
<i>Excessive motor noise.</i>	Component failure.	Return your unit for servicing.
<i>Display error message: High leak in last session.</i>	You have experienced excessively high leak levels during the night.	Check that your air tubing is connected properly and that your mask does not leak excessively. Use the mask-fitting feature to help you to fit your mask properly. If this message appears again, contact your clinician.

System Specifications

Dynamic pressure characteristics

IPAP: 2 cm H₂O to 25 cm H₂O (measured at the end of standard 2 m air tubing)

EPAP: 2 cm H₂O to 25 cm H₂O (measured at the end of standard 2 m air tubing)

CPAP: 4 to 20 cm H₂O (measured at the end of standard 2 m air tubing)

Maximum single fault pressure: 40 cm H₂O

Maximum flow (CPAP mode, measured at the end of standard 2 m air tubing)

Pressure (cm H ₂ O)	Flow (L/min)
10	200
15	170
20	150

Sound pressure level: <30 dB (tested in accordance with the requirements of ISO 17510-1:2002)

Dimensions (L x W x H): 270 mm x 230 mm x 141 mm

Weight: 2.3 kg

Air outlet: 22 mm taper, compatible with EN 1281-1:1997 Anaesthetic & Respiratory Equipment - Conical Connectors

Pressure measurement: Internally mounted pressure transducer

Flow measurement: Internally mounted flow transducer

Power Supply: Input range 100–240V, 50–60Hz, 40VA (typical power consumption), < 100VA (maximum power consumption)

Housing Construction: Flame retardant engineering thermoplastic

Environmental Conditions

Operating Temperature: +5°C to +40°C

Operating Humidity: 10%–95% non-condensing

Storage and Transport Temperature: -20°C to +60°C

Storage and Transport Humidity: 10–95% non-condensing

Electromagnetic Compatibility

Product complies with all applicable electromagnetic compatibility requirements (EMC) according to IEC60601-1-2, for residential, commercial and light industry environments. For further details, see “Guidance and Manufacturer’s Declaration - Electromagnetic Emissions and Immunity” on page 39.

Air Filter: Two-layered, powder-bonded, polyester non-woven fibre

Air Tubing: Flexible plastic, 2 m or 3 m length

IEC 60601-1 Classifications

Class II (double insulation)

Type CF

Table 7: Displayed values

Value	Range	Accuracy	Display Resolution
Pressure sensor at air outlet			
Pressure	-5 to 30 cm H ₂ O	±0.5 cm H ₂ O	0.1 cm H ₂ O
Flow sensor in flow generator*			
Leak	0–120 L/min	**	1 L/min
Tidal volume	100–3000 mL	**	1 mL
Respiratory rate	6–60 BPM	±0.5 BPM	0.1 BPM
Minute ventilation	0.6–60 L/min	**	0.25 L/min

* Results may be inaccurate in the presence of leaks.

** The displayed values are estimates. They are provided for trending purposes only.

Pressure Variation

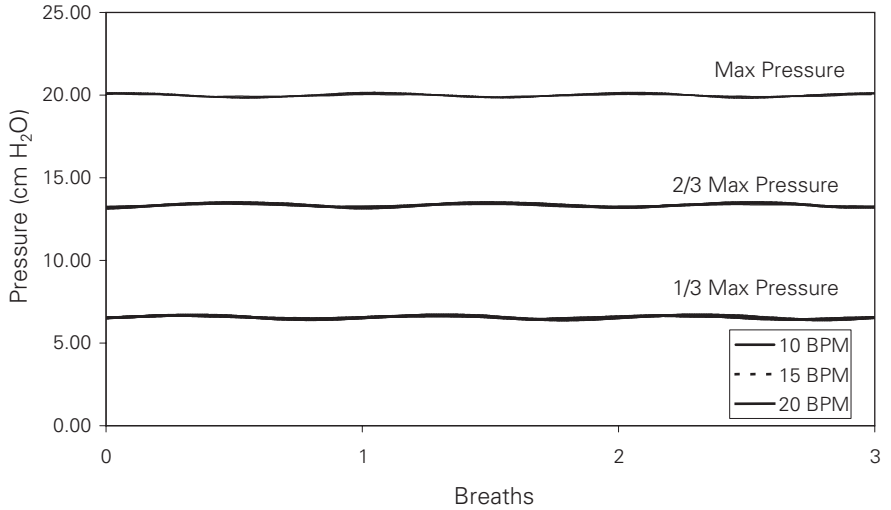

Pressure Volume curve

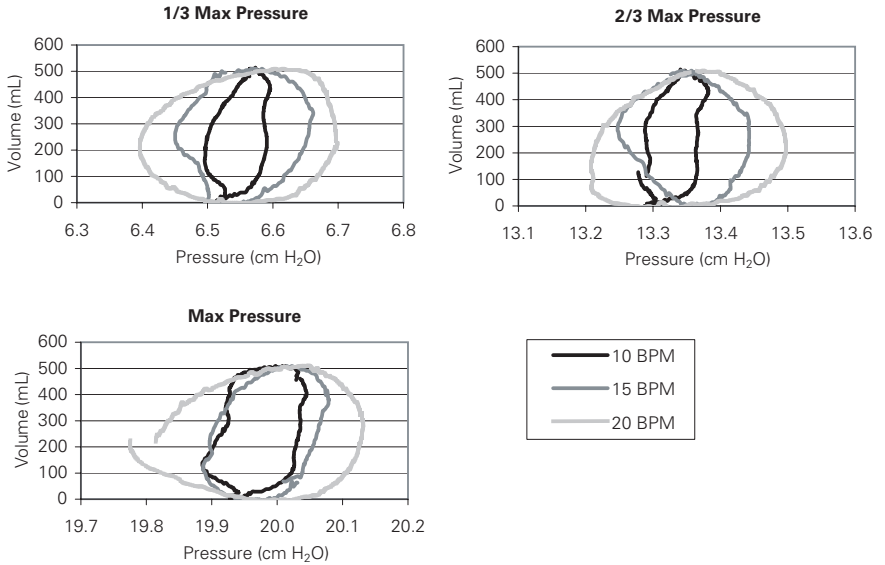

Note: The manufacturer reserves the right to change these specifications without notice.

Symbols which appear on the product



Attention, consult accompanying documents



Class II equipment



Type CF equipment



Drip Proof



Start/Stop or Mask-Fit



Environmental information

WEEE 2002/96/EC is a European Directive that requires the proper disposal of electrical and electronic equipment. This device should be disposed of separately, not as unsorted municipal waste. To dispose of your device, you should use appropriate collection, reuse and recycling systems available in your region. The use of these collection, reuse and recycling systems is designed to reduce pressure on natural resources and prevent hazardous substances from damaging the environment.

If you need information on these disposal systems, please contact your local waste administration. The crossed-bin symbol invites you to use these disposal systems. If you require information on collection and disposal of your ResMed device please contact your ResMed office, local distributor or go to www.resmed.com/environment.

Guidance and Manufacturer's Declaration - Electromagnetic Emissions and Immunity

Guidance and manufacturer's declaration – electromagnetic emissions

The VPAP is intended for use in the electromagnetic environment specified below. The customer or the user of the VPAP should assure that it is used in such an environment.

Emissions test	Compliance	Electromagnetic environment - guidance
RF emissions CISPR11	Group 1	The VPAP uses RF energy only for its internal function. Therefore, its RF emissions are very low and are not likely to cause any interference in nearby electronic equipment.
RF emissions CISPR 11	Class B	The VPAP is suitable for use in all establishments, including domestic establishments and those directly connected to the public low-voltage network that supplies buildings used for domestic purposes.
Harmonic Emissions IEC 61000-3-2	Class A	
Voltage Fluctuations/Flicker Emissions IEC 61000-3-3	Complies	

Medical Electrical Equipment needs special precautions regarding EMC and needs to be installed and put into service according to EMC information provided in this document.

Warnings: The VPAP should not be used adjacent to or stacked with other equipment. If adjacent or stacked use is necessary, the VPAP should be observed to verify normal operation in the configuration in which it will be used.

The use of accessories (eg humidifiers) other than those specified in this manual is not recommended. They may result in increased emissions or decreased immunity of the VPAP.

Guidance and manufacturer's declaration – electromagnetic immunity

The VPAP is intended for use in the electromagnetic environment specified below. The customer or the user of the VPAP should assure that it is used in such an environment.

Immunity test	IEC60601-1-2 test level	Compliance level	Electromagnetic environment – guidance
Electrostatic discharge (ESD) IEC 61000-4-2	±6 kV contact ±8 kV air	±6 kV contact ±8 kV air	Floors should be wood, concrete or ceramic tile. If floors are covered with synthetic material, the relative humidity should be at least 30%.
Electrical fast transient/burst IEC 61000-4-4	±2 kV for power supply lines ±1 kV for input/output lines	±2 kV Not Applicable	Mains power quality should be that of a typical commercial or hospital environment.
Surge IEC 61000-4-5	±1 kV differential mode ±2 kV common mode	±1 kV differential mode ±2 kV common mode	Mains power quality should be that of a typical commercial or hospital environment.
Voltage dips, short interruptions and voltage variations on power supply input lines. IEC 61000-4-11	<5% Ut (>95% dip in Ut) for 0.5 cycle 40% Ut (60% dip in Ut) for 5 cycles 70% Ut (30% dip in Ut) for 25 cycles <5% Ut (>95% dip in Ut) for 5 sec	< 12V (>95% dip in 240V) for 0.5 cycle 96V (60% dip in 240V) for 5 cycles 168V (30% dip in 240V) for 25 cycles <12V (>95% dip in 240V) for 5 sec	Mains power quality should be that of a typical commercial or hospital environment. If the user of the VPAP requires continued operation during power mains interruptions, it is recommended that the VPAP be powered from an uninterruptible power source
Power frequency (50/60 Hz) magnetic field IEC 61000-4-8	3 A/m	3 A/m	Power frequency magnetic fields should be at levels characteristic of a typical location in a typical commercial or hospital environment

NOTE: Ut is the a.c. mains voltage prior to application of the test level.

(Continued next page)

Guidance and manufacturer's declaration – electromagnetic immunity (Continued)

The VPAP is intended for use in the electromagnetic environment specified below. The customer or the user of the VPAP should assure that it is used in such an environment.

Immunity test	IEC60601-1-2 test level	Compliance level	Electromagnetic environment – guidance
<p>Conducted RF IEC 61000-4-6</p> <p>Radiated RF IEC 61000-4-3</p>	<p>3 Vrms 150 kHz to 80 MHz</p> <p>10 V/m 80 MHz to 2.5 GHz</p>	<p>3 Vrms</p> <p>10 V/m</p>	<p>Portable and mobile RF communications equipment should be used no closer to any part of the VPAP, including cables, than the recommended separation distance calculated from the equation applicable to the frequency of the transmitter.</p> <p>Recommended separation distance</p> <p>$d = 1.17 \sqrt{P}$</p> <p>$d = 0.35 \sqrt{P}$ 80 MHz to 800 MHz</p> <p>$d = 0.70 \sqrt{P}$ 800 MHz to 2.5 GHz</p> <p>where P is the maximum output power rating of the transmitter in watts (W) according to the transmitter manufacturer and d is the recommended separation distance in meters (m).</p> <p>Field strengths from fixed RF transmitters, as determined by an electromagnetic site survey,^a should be less than the compliance level in each frequency range.^b</p> <p>Interference may occur in the vicinity of equipment marked with the following symbol:</p> <div style="text-align: center;">  </div>

NOTE 1: At 80 MHz and 800 MHz, the higher frequency range applies.

NOTE 2: These guidelines may not apply in all situations. Electromagnetic propagation is affected by absorption and reflection from structures, objects and people.

^a Field strengths from fixed transmitters, such as base stations for radio (cellular/cordless) telephones and land mobile radios, amateur radio, AM and FM radio broadcast and TV broadcast cannot be predicted theoretically with accuracy. To assess the electromagnetic environment due to fixed RF transmitters, an electromagnetic site survey should be considered. If the measured field strength in the location in which the VPAP is used exceeds the applicable RF compliance level above, the VPAP should be observed to verify normal operation. If abnormal performance is observed, additional measures may be necessary, such as reorienting or relocating the VPAP.

^b Over the frequency range 150 kHz to 80 MHz, field strengths should be less than 10 V/m.

Recommended separation distances between portable and mobile RF communications equipment and the VPAP

The VPAP is intended for use in an environment in which radiated RF disturbances are controlled. The customer or the user of the VPAP can help prevent electromagnetic interference by maintaining a minimum distance between portable and mobile RF communications equipment (transmitters) and the VPAP as recommended below, according to the maximum output power of the communications equipment.

Rated maximum output power of transmitter W	Separation distance according to frequency of transmitter m		
	150 kHz to 80 MHz $d = 1.17 \sqrt{P}$	80 MHz to 800 MHz $d = 0.35 \sqrt{P}$	800 MHz to 2.5 GHz $d = 0.35 \sqrt{P}$
0.01	0.17	0.04	0.04
0.1	0.37	0.11	0.11
1	1.17	0.35	0.35
10	3.69	1.11	1.11
100	11.70	3.50	3.50

For transmitters rated at a maximum output power not listed above, the recommended separation distance d in metres (m) can be determined using the equation applicable to the frequency of the transmitter, where P is the maximum output power rating of the transmitter in watts (W) according to the transmitter manufacturer.

NOTE 1: At 80 MHz and 800 MHz, the separation distance for the higher frequency range applies.

NOTE 2: These guidelines may not apply in all situations. Electromagnetic propagation is affected by absorption and reflection from structures, objects and people.

Limited Warranty

ResMed warrants that your ResMed product shall be free from defects in material and workmanship for the period specified below from the date of purchase by the initial consumer. This warranty is not transferable.

Product	Warranty Period
ResMed humidifiers, ResControl™, ResLink™, ResTraxx™	1 Year
ResMed flow generators	2 Years
Accessories, mask systems (including mask frame, cushion, headgear and tubing). Excludes single-use devices.	90 Days

Note: *Some models are not available in all regions.*

If the product fails under conditions of normal use, ResMed will repair or replace, at its option, the defective product or any of its components. This Limited Warranty does not cover:

- a) any damage caused as a result of improper use, abuse, modification or alteration of the product;
- b) repairs carried out by any service organization that has not been expressly authorized by ResMed to perform such repairs;
- c) any damage or contamination due to cigarette, pipe, cigar or other smoke;
- d) any damage caused by water being spilled on or into a flow generator.

Warranty is void on product sold, or resold, outside the region of original purchase. Warranty claims on defective product must be made by the initial consumer at the point of purchase.

This warranty is in lieu of all other express or implied warranties, including any implied warranty of merchantability or fitness for a particular purpose. Some regions or states do not allow limitations on how long an implied warranty lasts, so the above limitation may not apply to you.

ResMed shall not be responsible for any incidental or consequential damages claimed to have occurred as a result of the sale, installation or use of any ResMed product. Some regions or states do not allow the exclusion or limitation of incidental or consequential damages, so the above limitation may not apply to you. This warranty gives you specific legal rights, and you may also have other rights which vary from region to region.

For further information on your warranty rights, contact your local ResMed dealer or ResMed office.

R001-307/2 05 06

Index

A

Accessories 6
Air filter 18, 35
air tubing 36
 cleaning 17

B

Back-light, LCD and Keypad 10

C

Cautions 2
cleaning
 periodic 17
 weekly 17
Cleaning and Maintenance 17
cleaning mask 17
Cleaning Periodically 17

D

Daily Cleaning 17
definitions 1
Detailed Menu 20, 21
Dimensions 35
Dryness 29
Dynamic pressure characteristics 35

E

Electromagnetic Compatibility 35
Environmental Conditions 35
Error Messages 32

F

Front Key 10

G

Glossary of Symbols 38

H

Helpful Hints 29
High Leak Message 23
Housing Construction 35
how to use the VPAP 7
HumidAire 8
HumidAire 2i 8
HumidAire 2iC 8
Humidifier 6
 cleaning 17
Humidifier Use 7

I

IEC 60601-1 Classifications 36
International Use 29

K

keypad 10
Keys, functions 10

L

LCD screen 10
Left Key 11

M

Mask Alarm 23
Mask Fitting 29
mask settings 23
mask types 23
Mask-Fit Star Rating, definitions 15
Mask-Fitting Feature 14
Masks 5
maximum flow 35
Medical Information 1
Menu Functions 22
menu type 19
Menus, using the VPAP 19
Mouth Leaks 29

N

Nasal Irritation 29

O

Operating Instructions 13
Options Menu 25

P

Passover 9
periodic cleaning 17
Power Supply 35

R

Ramp Screen 19
Ramp time 19
Replacing the Air Filter 18
Responsibility, user/owner 1
Results Menu 24
Right Key 11
Runny or Blocked Nose 29

S

Servicing 18
Servicing Menu 25
setting up 7
Settings Menu 22
SmartStart 23
Standard Menu 20
Starting Treatment 13
Stopping Treatment 14
System Specifications 35

T

Travelling 29
treatment screen 26
Troubleshooting 31

U

Up/Down Key 10
Used (time) screen 19
User/Owner Responsibility 1
Using the Mask-Fitting feature 14
Using the Menus 19

W

Weekly Cleaning 17
weekly cleaning 17
Weight 35